

SPRING-LOADED CONNECTORS

SERIES 1593 • LOW PROFILE TARGET DISCS • SURFACE MOUNT

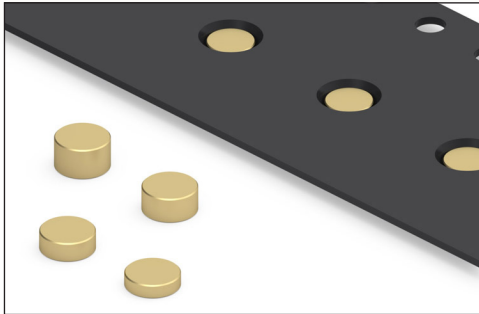

- The 1593-X-57-15-00-00-03-0 Surface mount disc is 2,36mm in diameter and available in four heights from 0,64 to 1,4 +/-0,051. Employing our precision machining expertise we are able to achieve flat surfaces on both sides of the disc with virtually no burrs. The flat surfaces are ideal for surface mount soldering and as the conductive mating surface for spring loaded pins and connectors as well as test probes. The discs are typically placed on solder pasted PCB pads and then subjected to reflow soldering. Once soldered the terminals are ready to be used as reliable, durable contact points.
- The 1593-X's are packaged on tape & reel - 16 mm wide x 8 mm pitch, making them simple to integrate into existing pick & place equipment and assembly processes. The tape packaging is per EIA-481-D
- Custom sizes are quickly and easily achievable via Mill-Max's high speed precision machining processes. You can contact our technical support team to discuss your particular application and requirements.

Series 1593 (Target Disc)

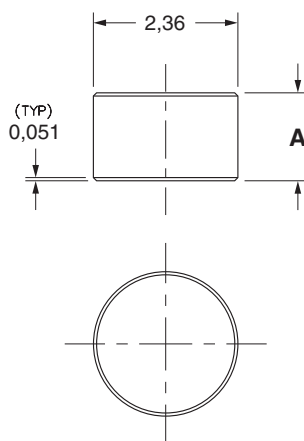

Series 1593 (Tape Pocket Details)

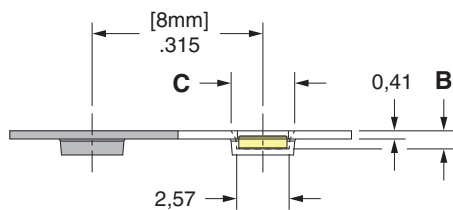

Series 1593 (Suggested footprint layout)

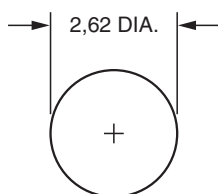

ORDERING INFORMATION

Series 1593 (Tape & Reel Packaged)

1593-X-57-15-00-00-03-0

Specify contact style (0-3)

Contact Style	Target Disc Height (A)	Tape Pocket Depth (B)	Tape Pocket Opening (C)	Quantity per Reel
0	0,64	0,89	3,12	7,200
1	0,89	1,14	3,15	6,000
2	1,14	1,4	3,15	5,125
3	1,4	1,65	3,15	4,000

XX=Plating Code
See Below

For
Electrical, Mechanical
& Environmental Data,
See page 264

SPECIFY PLATING CODE XX=

15

Pin Plating



0,25 µm Au

SPECIFICATIONS:

Pin Material: Brass Alloy 385 or 360, 1/2 Hard

Dimensions: Inches

Tolerances On: Lengths: ± 0,051
Diameters: ± 0,025
Angles: ± 2°

RoHS-2
2011/65/EU