



WWW.MILL-MAX.COM

# SPRING-LOADED CONNECTORS





WWW.MILL-MAX.COM

**MILL-MAX SPRING-LOADED CONNECTORS ARE IDEAL FOR A WIDE RANGE OF APPLICATIONS**, from portable data acquisition units and mobile communication to medical and military equipment applications. Their unique design can be the perfect solution for many situations where establishing an electrical path between mating points is a challenge, including problematic vibratory environments.

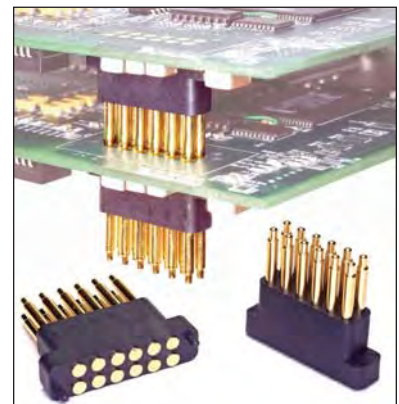
When strategically placed within an assembly and utilized correctly (shielded from over compression and direct side load forces,) spring-loaded connectors provide a reliable connection exceeding a million cycles.

**SOME TYPICAL APPLICATIONS INCLUDE:**

- The internal battery connection in portable instruments, or as the external battery connection for charging these instruments (docking stations).
- As a method for stacking printed circuit boards in an assembly. Utilizing spring pin connectors is a convenient approach to creating mezzanine-tiered board modules that can be assembled and disassembled quickly.
- Blind-mating applications: The spring pin piston need only make contact with its mating surface. This is typically a land or pad that is larger than the plunger diameter. In situations where the assembly process doesn't allow for visibility, spring pins are the optimum choice.

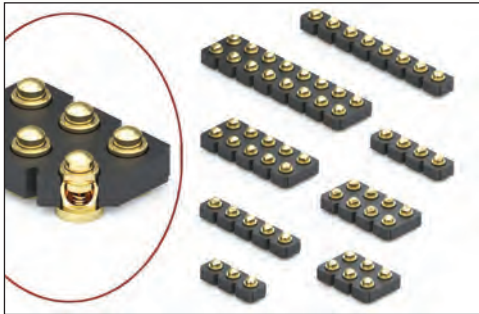
**MILL-MAX SPRING-LOADED CONNECTORS CAN MATE TO THE FOLLOWING SURFACES:**

- A conductive input/output pad found on the instrument pack itself.
- A gold-plated land on a circuit board. A hard gold over nickel-plated surface is recommended for the mating surface. This is the same as would be used for the printed circuit fingers associated with card edge connectors.
- Individual Mill-Max gold-plated nail head pins which can be soldered to the mating circuit board to serve as targets.
- Mill-Max Target Connectors which provide a large, flat gold-plated circuit path to the board.



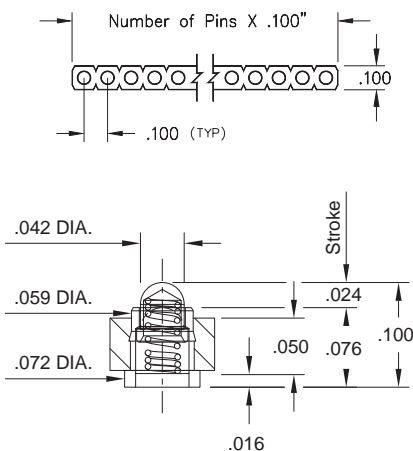
# SPRING-LOADED CONNECTORS

## SERIES 815 & 817 • .100" GRID SURFACE MOUNT, ULTRA LOW PROFILE • SINGLE AND DOUBLE ROW STRIPS

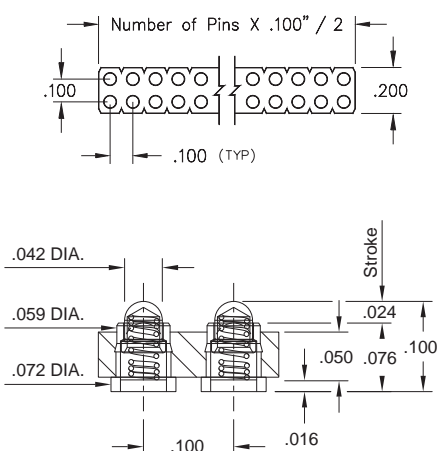


- Modular contacts for use on .100" grid, available in a height of .100", supplied in single and double row contact strips
- Precision-machined piston / base and gold-plated components assure up to 1,000,000 cycle life durability
- Pistons have a .012" mid. stroke and a .024" max. stroke
- Low resistance, high current contacts are rated at 2 amps continuous, 3 amps peak
- High temperature thermoplastic insulators are suitable for surface mount processes
- 815 & 817 series contact strips are designed for manual placement onto a .082" Ø solder pad prior to reflow soldering

### SINGLE ROW Series 815



### DOUBLE ROW Series 817



## ORDERING INFORMATION

### Single Row Series 815

815-22-0XX-30-001101

Specify number of contacts 01-32

For 815 and 817 Tape & Reel packaging, see page 12.1

### Double Row Series 817

817-22-0XX-30-001101

Specify number of contacts 04-72

For 815 and 817 Tape & Reel packaging, see page 12.1

## Technical Specifications

### Materials:

Contact piston & base: Machined copper alloy plated 20µ" gold over 100µ" nickel  
 Spring: Beryllium copper-plated 10µ" gold  
 Insulator: High temperature thermoplastic, rated UL94 V-0

### Mechanical:

Spring force @ initial height: 25 grams  
 Spring force @ mid stroke (.012"): 60 grams  
 Durability: Up to 1,000,000 cycles  
 Coplanarity: .005" (Single Row up to 10 pins; Double Row up to 20 pins),  
 For higher pin counts, contact Technical Support

### Electrical:

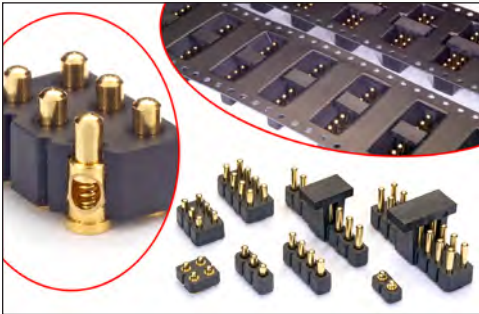
Voltage rating: 100Vrms/150Vdc  
 Current rating: 2A (continuous), 3A (peak) per contact  
 Contact resistance: 20mΩ max.  
 Insulation resistance: 10,000MΩ min.  
 Dielectric strength: 700Vrms min.  
 Capacitance: 1pF max.

RoHS-2  
2011/65/EU



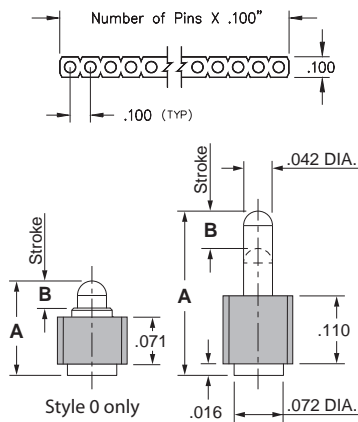
# SPRING-LOADED CONNECTORS

## SERIES 811 & 813 • .100" GRID SURFACE MOUNT, LOW PROFILE • SINGLE AND DOUBLE ROW STRIPS



- Modular contacts for use on .100" grid, available in five heights from .137" to .236", supplied in single and double row contact strips
- Precision-machined piston / base and gold-plated components assure up to 1,000,000 cycle life durability
- Pistons have a long stroke relative to the low profile of the assembly
- Low resistance, high current contacts are rated at 2 amps continuous, 3 amps peak
- High temperature thermoplastic insulators are suitable for surface mount processes
- Both 811 & 813 series, contact styles 1 through 4, are available on 32mm wide carrier tape and fitted with vacuum pick-up clips for automated pick and place assembly. Tape and Reel packaging per EIA-481. See page 12 for strip lengths available and ordering information

### SINGLE ROW Series 811



## ORDERING INFORMATION

### Single Row Series 811

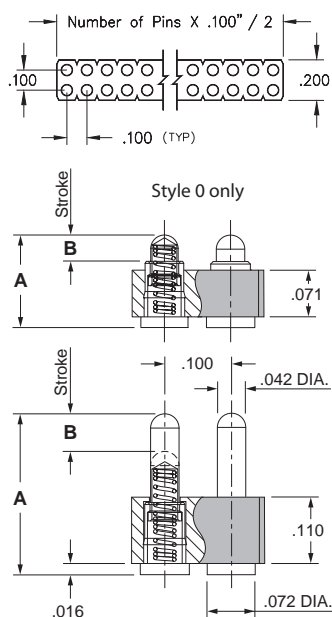
811-22-0XX-30-00X101  
**Specify number of contacts** 01-64      **Specify contact style** 0-4

### Double Row Series 813

813-22-0XX-30-00X101  
**Specify number of contacts** 04-72      **Specify contact style** 0-4  
 For 811 and 813 Tape & Reel packaging, see page 12

CONTACT STYLE	INITIAL HEIGHT A	MAX. STROKE B
0	.137	.039
1	.177	.045
2	.197	.055
3	.217	.055
4	.236	.055

### DOUBLE ROW Series 813



### Technical Specifications

#### Materials:

Contact piston & base: Machined copper alloy plated 20μ" gold over 100μ" nickel  
 Spring: Beryllium copper-plated 10μ" gold  
 Insulator: High temperature thermoplastic, rated UL94 V-0

#### Mechanical:

Spring force @ initial height (A): 25 grams  
 Spring force @ mid stroke (B/2): 60 grams  
 Durability: Up to 1,000,000 cycles  
 Coplanarity: .005" (Single Row up to 10 pins; Double Row up to 20 pins),  
 For higher pin counts, contact Technical Support

#### Electrical:

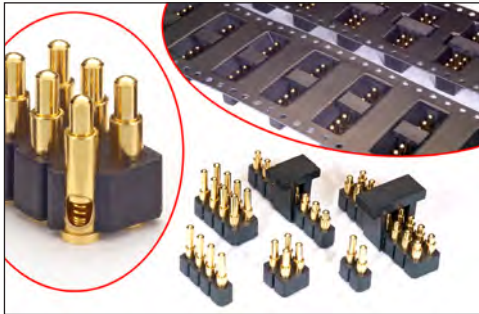
Voltage rating: 100Vrms/150Vdc  
 Current rating: 2A (continuous), 3A (peak) per contact  
 Contact resistance: 20mΩ max.  
 Insulation resistance: 10,000MΩ min.  
 Dielectric strength: 700Vrms min.  
 Capacitance: 1pF max.

RoHS-2  
2011/65/EU



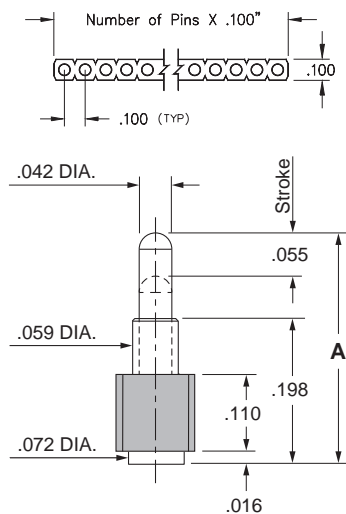
# SPRING-LOADED CONNECTORS

## SERIES 812 & 814 • .100" GRID SURFACE MOUNT, MID PROFILE • SINGLE AND DOUBLE ROW STRIPS

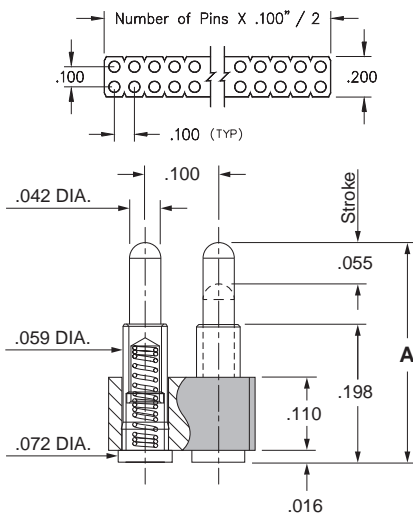


- Modular contacts for use on .100" grid, available in ten heights from .255" to .430", supplied in single and double row contact strips
- Precision-machined piston / base and gold-plated components assure up to 1,000,000 cycle life durability
- Extended body provides greater bearing surface for increased strength & plunger protection
- Low resistance, high current contacts are rated at 2 amps continuous, 3 amps peak
- High temperature thermoplastic insulators are suitable for surface mount processes
- Both 812 & 814 series, contact styles 0 through 9, are available on 32mm or 44mm wide carrier tape and fitted with vacuum pick-up clips for automated pick and place assembly. Tape and Reel packaging per EIA-481. See page 12 for strip lengths available and ordering information

### SINGLE ROW Series 812



### DOUBLE ROW Series 814



## ORDERING INFORMATION

### Single Row Series 812

812-22-0XX-30-00X101

Specify number of contacts 02-64      Specify contact style 0-9

### Double Row Series 814

814-22-0XX-30-00X101

Specify number of contacts 04-72      Specify contact style 0-9

For 812 and 814 Tape & Reel packaging, see page 12

CONTACT STYLE	INITIAL HEIGHT A	CONTACT STYLE	INITIAL HEIGHT A
0	.255	5	.350
1	.275	6	.370
2	.295	7	.390
3	.315	8	.410
4	.335	9	.430

## Technical Specifications

### Materials:

Contact piston & base: Machined copper alloy plated 20μ" gold over 100μ" nickel  
 Spring: Beryllium copper-plated 10μ" gold  
 Insulator: High temperature thermoplastic, rated UL94 V-0

### Mechanical:

Spring force @ initial height (A): 25 grams  
 Spring force @ mid stroke (.0275"): 60 grams  
 Durability: Up to 1,000,000 cycles  
 Coplanarity: .005" (Single Row up to 10 pins; Double Row up to 20 pins),  
 For higher pin counts, contact Technical Support

### Electrical:

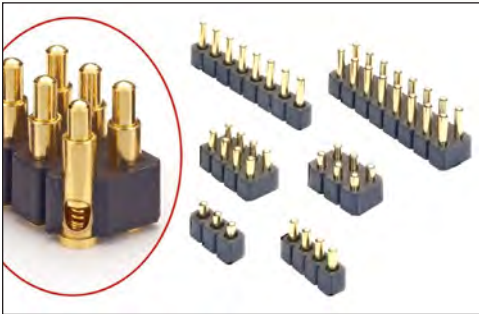
Voltage rating: 100Vrms/150Vdc  
 Current rating: 2A (continuous), 3A (peak) per contact  
 Contact resistance: 20mΩ max.  
 Insulation resistance: 10,000MΩ min.  
 Dielectric strength: 700Vrms min.  
 Capacitance: 1pF max.

RoHS-2  
2011/65/EU



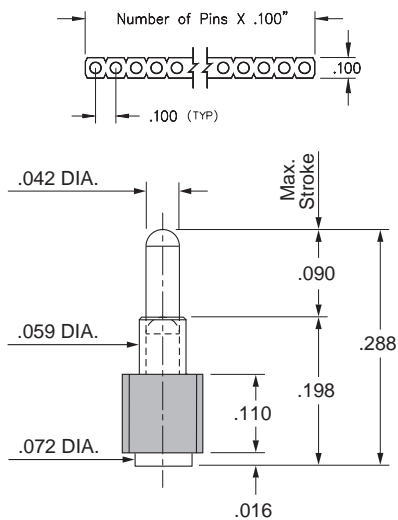
# SPRING-LOADED CONNECTORS

## SERIES 819 & 820 • .100" GRID SURFACE MOUNT, LONG STROKE • SINGLE AND DOUBLE ROW STRIPS



- Modular contacts for use on .100" grid, available in a height of .288", supplied in single and double row contact strips
- Precision-machined piston / base and gold-plated components assure up to 1,000,000 cycle life durability
- Pistons have a .045" mid. stroke and a .090" max. stroke
- Low resistance, high current contacts are rated at 2 amps continuous, 3 amps peak
- High temperature thermoplastic insulators are suitable for surface mount processes
- Both 819 & 820 series contact strips are designed for placement onto a Ø.082" solder pad prior to reflow soldering
- Both 819 & 820 series, are available on carrier tape and fitted with vacuum pick-up clips for automated pick and place assembly. Tape and Reel packaging per EIA-481. See page 12.1 for strip lengths available and ordering information

### SINGLE ROW Series 819



## ORDERING INFORMATION

### Single Row Series 819

819-22-0XX-30-001101

Specify number of contacts 01-64

For 819 and 820 Tape & Reel packaging, see page 12.1

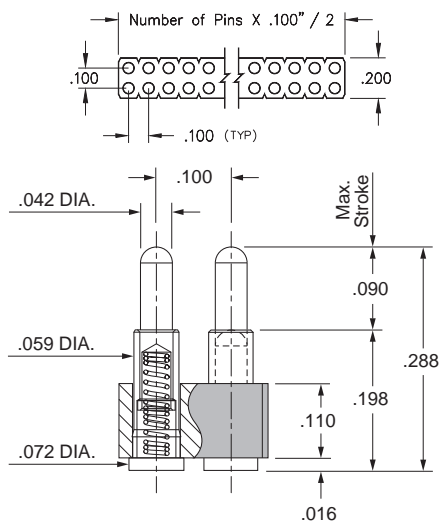
### Double Row Series 820

820-22-0XX-30-001101

Specify number of contacts 04-72

For 819 and 820 Tape & Reel packaging, see page 12.1

### DOUBLE ROW Series 820



### Technical Specifications

#### Materials:

Contact piston & base: Machined copper alloy plated 20μ" gold over 100μ" nickel  
 Spring: Beryllium copper-plated 10μ" gold  
 Insulator: High temperature thermoplastic, rated UL94 V-0

#### Mechanical:

Spring force @ initial height: 25 grams  
 Spring force @ mid stroke (.045"): 60 grams  
 Durability: Up to 1,000,000 cycles

#### Electrical:

Voltage rating: 100Vrms/150Vdc  
 Current rating: 2A (continuous), 3A (peak) per contact  
 Contact resistance: 20mΩ max.  
 Insulation resistance: 10,000MΩ min.  
 Dielectric strength: 700Vrms min.  
 Capacitance: 1pF max.

RoHS-2  
2011/65/EU



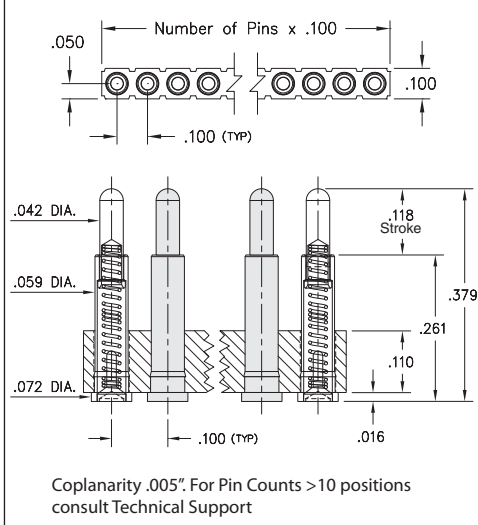
# SPRING-LOADED CONNECTORS

## SERIES 837 & 839 • .100" GRID SURFACE MOUNT, 3MM MAX. STROKE • SINGLE AND DOUBLE ROW STRIPS

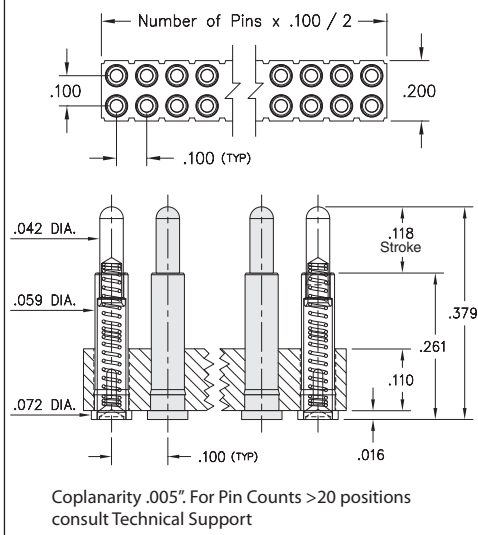


- Modular contacts for use on .100" grid, available in single and double row contact strips with recommended rated travel of .030" - .100" and max. stroke of .118" +0/-0.010"
- Precision-machined piston / base and gold-plated components
- Extended body provides greater bearing surface for increased strength & plunger protection
- Low resistance, high current contacts are rated at 2 amps continuous, 3 amps peak
- High temperature thermoplastic insulators are suitable for SMT soldering processes
- Both 837 & 839 series, are available on 44mm wide carrier tape and fitted with vacuum pick-up clips for automated pick and place assembly. Tape and Reel packaging per EIA-481
- 837 & 839 series contact strips are designed for manual or automatic placement onto .082" Ø solder pads

### SINGLE ROW Series 837



### DOUBLE ROW Series 839



## ORDERING INFORMATION

### Series 837 (Bulk Packaged)

837-22-0XX-30-001101

Specify number of contacts 01-64

### Series 837 (Tape & Reel Packaged, 200 parts per reel)

837-22-0XX-30-001191

Specify number of contacts 02-12

### Series 839 (Bulk Packaged)

839-22-0XX-30-001101

Specify number of contacts 04-72

### Series 839 (Tape & Reel Packaged, 200 parts per reel)

839-22-0XX-30-001191

Specify number of contacts 04-24

## Technical Specifications

### Materials:

Contact piston & base: Machined copper alloy plated 20µ" gold over 100µ" nickel

Spring: Stainless Steel-plated 10µ" gold

Insulator: High temperature thermoplastic, rated UL94 V-0

### Mechanical:

Spring force @ initial height: 25 grams

Spring force @ mid stroke (.059"): 85 grams

Durability: Up to 1,000,000 cycles

### Electrical:

Voltage rating: 100Vrms/150Vdc

Current rating: 2A (continuous), 3A (peak) per contact

Contact resistance: 20mΩ max.

Insulation resistance: 10,000MΩ min.

Dielectric strength: 700Vrms min.

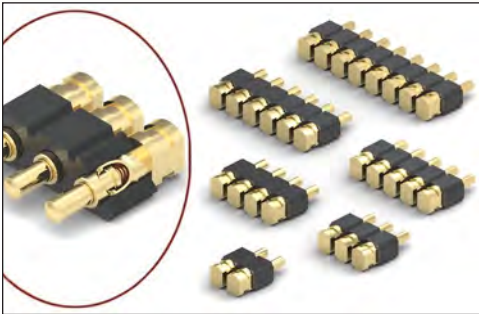
Capacitance: 1pF max.

RoHS-2  
2011/65/EU



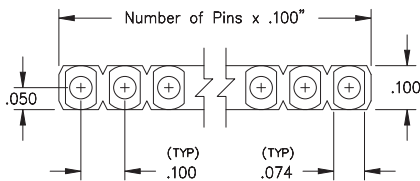
# SPRING-LOADED CONNECTORS

## SERIES 810 • .100" GRID HORIZONTAL SURFACE MOUNT • SINGLE ROW STRIPS

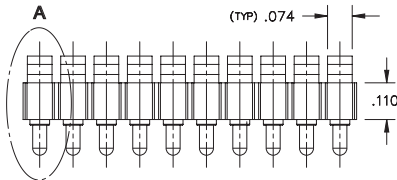


- Modular contacts for use on .100" grid, supplied in single row contact strips. Piston action is parallel to the board surface
- Ideal for daisy chaining of P.C.B.'s when mated with right angle target connectors (series 399...10-008) or for mating boards in a perpendicular orientation
- Precision-machined piston / base and gold-plated components assure up to 1,000,000 cycle life durability
- Pistons have a .045" mid. stroke & .090" max. stroke
- Low resistance, high current contacts are rated at 2 amps continuous, 3 amps peak
- High temperature thermoplastic insulators are suitable for surface mount processes
- 810 series contact strips are designed for manual placement onto solder pads

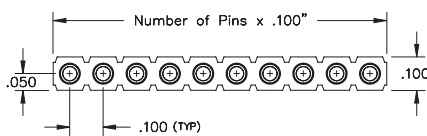
### SINGLE ROW Series 810



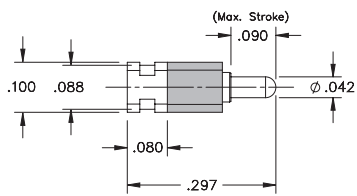
#### TOP VIEW



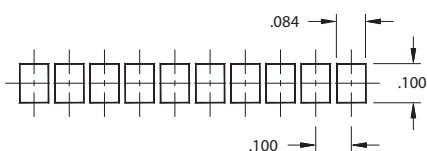
#### FRONT VIEW



#### DETAIL 'A'



### Suggested P.C.B. FOOTPRINT



Coplanarity .005". For Pin Counts >10 positions consult Technical Support

## ORDERING INFORMATION

### Single Row Series 810

810-22-0XX-40-001101

Specify number of contacts 01-10

### Technical Specifications

#### Materials:

Contact piston & base: Machined copper alloy plated 20μ" gold over 100μ" nickel  
 Spring: Beryllium copper-plated 10μ" gold  
 Insulator: High temperature thermoplastic, rated UL94 V-0

#### Mechanical:

Spring force @ initial height: 25 grams  
 Spring force @ mid stroke (.045"): 60 grams  
 Durability: Up to 1,000,000 cycles

#### Electrical:

Voltage rating: 100Vrms/150Vdc  
 Current rating: 2A (continuous), 3A (peak) per contact  
 Contact resistance: 20mΩ max.  
 Insulation resistance: 10,000MΩ min.  
 Dielectric strength: 700Vrms min.  
 Capacitance: 1pF max.

RoHS-2  
2011/65/EU





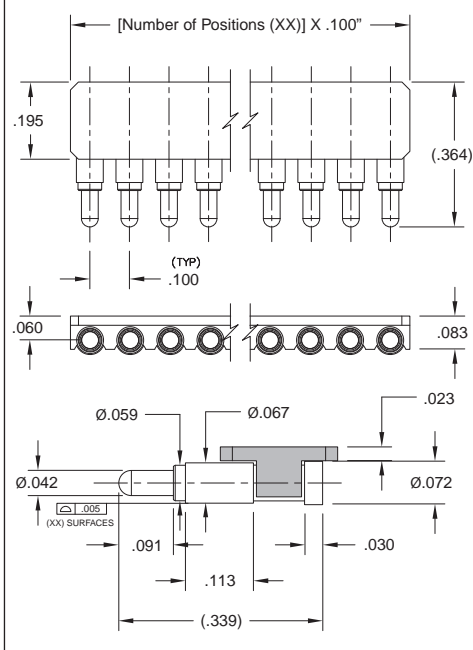
# SPRING-LOADED CONNECTORS

## SERIES 810 • .100" GRID HORIZONTAL SURFACE MOUNT • SINGLE ROW STRIPS

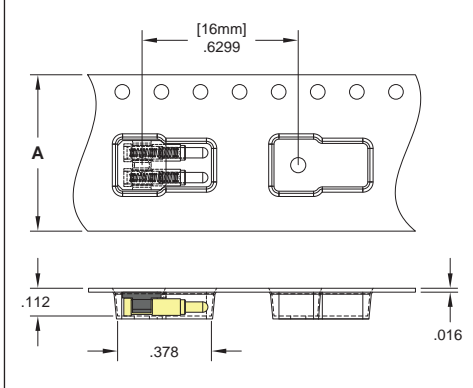


- Modular contacts for use on .100" grid, supplied in single row contact strips. Piston action is parallel to the board surface
- Ideal for daisy chaining of P.C.B.'s when mated with horizontal surface mount target connectors series 319-10-1XX-40-080001 or for mating boards in a perpendicular orientation
- Pistons have a .045" mid. stroke & .090" max. stroke
- High temperature thermoplastic insulators are suitable for surface mount processes
- The 810 series are packaged on tape & reel - 16, 24, 32 or 44 mm wide x 16 mm pitch, making them simple to integrate into existing pick & place equipment and assembly processes. The tape packaging is per EIA-481-D

### Series 810 Single Row



### Series 810 (Tape Pocket Details)



## ORDERING INFORMATION

### Series 810 (Tape & Reel Packaged)

810-22-0XX-40-005191

Specify number of contacts 02-10

Number of Contacts	Tape Width Size (A)	Quantity per Reel
2	16mm	1,450
3	16mm	1,450
4	24mm	1,450
5	24mm	1,450
6	24mm	1,450
7	32mm	1,450
8	32mm	1,450
9	44mm	1,450
10	44mm	1,450

### Technical Specifications

#### Materials:

Contact piston & base: Machined copper alloy plated 20 $\mu$ " gold over 100 $\mu$ " nickel  
 Spring (Contact style 2-10): Beryllium copper-plated 10 $\mu$ " gold  
 Insulator: High temperature thermoplastic, rated UL94 V-0

#### Mechanical:

Spring force @ initial height (Contact style 2-10): 25 grams  
 Spring force @ mid stroke (Contact style 2-10): 60 grams  
 Durability: Up to 1,000,000 cycles

#### Electrical:

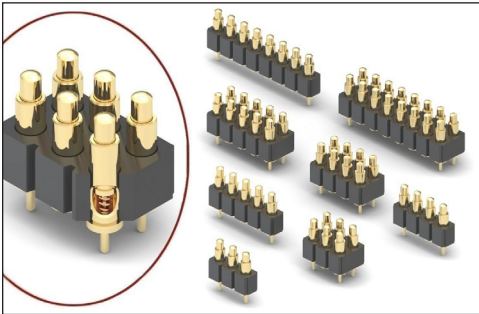
Current rating: 2A (continuous), 3A (peak) per contact  
 Contact resistance: 20m $\Omega$  max.  
 Insulation resistance: 10,000M $\Omega$  min.  
 Dielectric strength: 700Vrms min.

RoHS - 2  
2011/65/EU



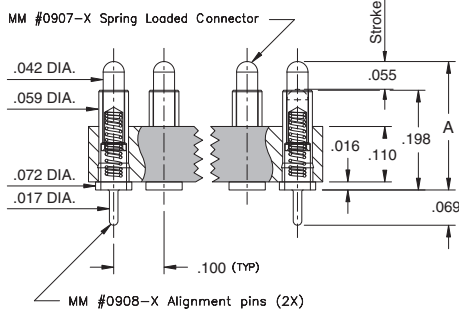
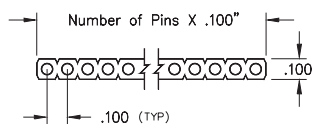
# SPRING-LOADED CONNECTORS

## SERIES 812 & 814 • .100" GRID SURFACE MOUNT WITH ALIGNMENT PINS • SINGLE AND DOUBLE ROW STRIPS

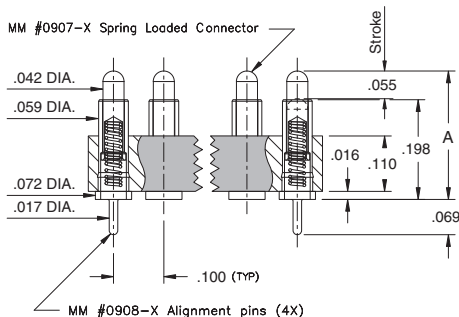
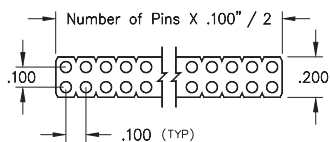


- Modular contacts for use on .100" grid, available in ten heights from .255" to .430", supplied in single and double row contact strips
- Precision-machined piston / base and gold-plated components assure up to 1,000,000 cycle life durability
- Pistons have a .0275" mid stroke & .055" max. stroke
- Low resistance, high current contacts are rated at 2 amps continuous, 3 amps peak
- High temperature thermoplastic insulators are suitable for surface mount processes
- Both 812 & 814 series contact strips are designed for manual placement, .028" ±.003" plated through-holes in the circuit board are required for the alignment pins prior to intrusive reflow soldering

### SINGLE ROW Series 812



### DOUBLE ROW Series 814



## ORDERING INFORMATION

### Single Row Series 812...01X101

812-22-0XX-30-01X101

Specify number of contacts 03-64

Specify contact style 0-9

### Double Row Series 814...01X101

814-22-0XX-30-01X101

Specify number of contacts 06-72

Specify contact style 0-9

CONTACT STYLE	INITIAL HEIGHT A	CONTACT STYLE	INITIAL HEIGHT A
0	.255	5	.350
1	.275	6	.370
2	.295	7	.390
3	.315	8	.410
4	.335	9	.430

### Technical Specifications

#### Materials:

Contact piston & base: Machined copper alloy plated 20μ" gold over 100μ" nickel  
 Spring: Beryllium copper-plated 10μ" gold  
 Insulator: High temperature thermoplastic, rated UL94 V-0

#### Mechanical:

Spring force @ initial height (A): 25 grams  
 Spring force @ mid stroke (.0275"): 60 grams  
 Durability: Up to 1,000,000 cycles

#### Electrical:

Voltage rating: 100Vrms/150Vdc  
 Current rating: 2A (continuous), 3A (peak) per contact  
 Contact resistance: 20mΩ max.  
 Insulation resistance: 10,000MΩ min.  
 Dielectric strength: 700Vrms min.  
 Capacitance: 1pF max.

RoHS-2  
2011/65/EU



# SPRING-LOADED CONNECTORS

## SERIES 811, 812, 813, 814 • .100" GRID SURFACE MOUNT • CARRIER TAPE AND PACKAGING

### Ordering Information for Series 811/812/813/814 in Carrier Tape

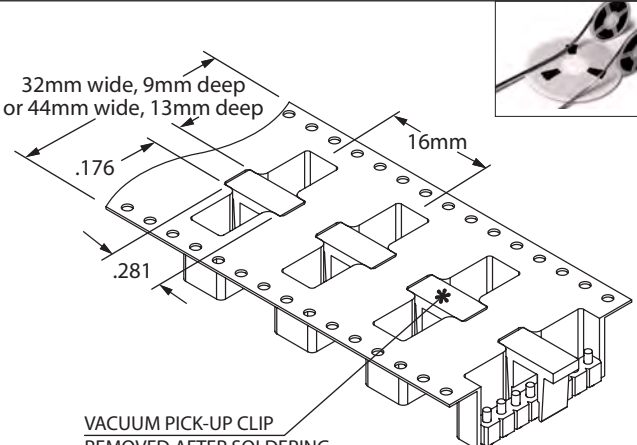
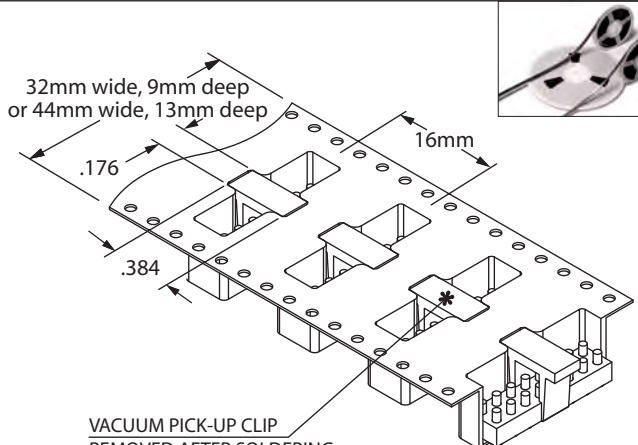
Single Row Series 811	Double Row Series 813
<p>811-22-0XX-30-00X191</p> <p>Specify contact style 0-4 Specify number of contacts 02-08 (32mm wide tape, 400 parts per 13" reel)</p>	<p>813-22-0XX-30-00X191</p> <p>Specify contact style 0-4 Specify number of contacts 04-16 (32mm wide tape, 400 parts per 13" reel)</p>
Single Row Series 811	Double Row Series 813
<p>811-22-0XX-30-00X191</p> <p>Specify contact style 1-4 Specify number of contacts 09-12 (44mm wide tape, 200 parts per 13" reel)</p>	<p>813-22-0XX-30-00X191</p> <p>Specify contact style 1-4 Specify number of contacts 18-24 (44mm wide tape, 200 parts per 13" reel)</p>
Single Row Series 812	Double Row Series 814
<p>812-22-0XX-30-00X191</p> <p>Specify contact style 0-2 Specify number of contacts 02-08 (32mm wide tape, 400 parts per 13" reel)</p>	<p>814-22-0XX-30-00X191</p> <p>Specify contact style 0-2 Specify number of contacts 04-16 (32mm wide tape, 400 parts per 13" reel)</p>
Single Row Series 812	Double Row Series 814
<p>812-22-0XX-30-00X191</p> <p>Specify contact style 0-2 Specify number of contacts 09-12 (44mm wide tape, 200 parts per 13" reel)</p>	<p>814-22-0XX-30-00X191</p> <p>Specify contact style 0-2 Specify number of contacts 18-24 (44mm wide tape, 200 parts per 13" reel)</p>
Single Row Series 812	Double Row Series 814
<p>812-22-0XX-30-00X191</p> <p>Specify contact style 3-9 Specify number of contacts 02-12 (44mm wide tape, 200 parts per 13" reel)</p>	<p>814-22-0XX-30-00X191</p> <p>Specify contact style 3-9 Specify number of contacts 04-24 (44mm wide tape, 200 parts per 13" reel)</p>



# SPRING-LOADED CONNECTORS

## SERIES 815, 817, 819, 820 • .100" GRID SURFACE MOUNT • CARRIER TAPE AND PACKAGING

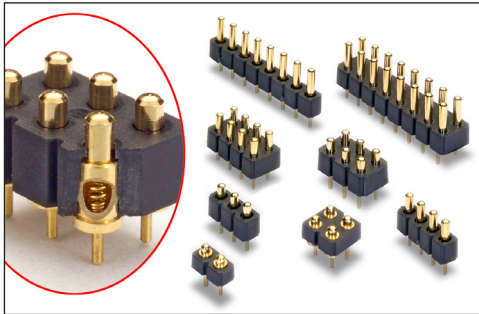
### Ordering Information for Series 815/817/819/820 in Carrier Tape

Single Row Series 815	Double Row Series 817
<p style="text-align: center;">815-22-0XX-30-001191</p> <p>Specify number of pins <span style="margin-left: 100px;">↑</span> 02-10</p> <p style="text-align: center;">( 44mm wide tape, 910 parts per 13" reel )</p>	<p style="text-align: center;">817-22-0XX-30-001191</p> <p>Specify number of pins <span style="margin-left: 100px;">↑</span> 04-20</p> <p style="text-align: center;">( 44mm wide tape, 680 parts per 13" reel )</p>
Single Row Series 819	Double Row Series 820
<p style="text-align: center;">819-22-0XX-30-001191</p> <p>Specify number of pins <span style="margin-left: 100px;">↑</span> 02-08</p> <p style="text-align: center;">( 32mm wide tape, 400 parts per 13" reel )</p>	<p style="text-align: center;">820-22-0XX-30-001191</p> <p>Specify number of pins <span style="margin-left: 100px;">↑</span> 04-16</p> <p style="text-align: center;">( 32mm wide tape, 400 parts per 13" reel )</p>
Single Row Series 819	Double Row Series 820
<p style="text-align: center;">819-22-0XX-30-001191</p> <p>Specify number of pins <span style="margin-left: 100px;">↑</span> 09-12</p> <p style="text-align: center;">( 44mm wide tape, 200 parts per 13" reel )</p>	<p style="text-align: center;">820-22-0XX-30-001191</p> <p>Specify number of pins <span style="margin-left: 100px;">↑</span> 18-24</p> <p style="text-align: center;">( 44mm wide tape, 200 parts per 13" reel )</p>
 <p style="text-align: center;">VACUUM PICK-UP CLIP REMOVED AFTER SOLDERING</p>	 <p style="text-align: center;">VACUUM PICK-UP CLIP REMOVED AFTER SOLDERING</p>



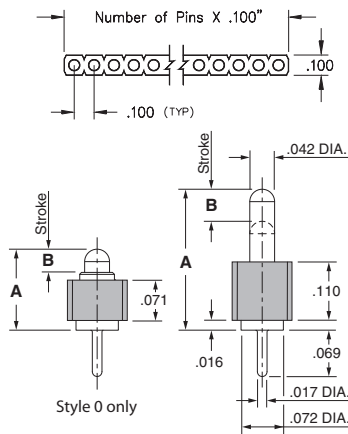
# SPRING-LOADED CONNECTORS

## SERIES 821 & 823 • .100" GRID THROUGH-HOLE MOUNT • SINGLE AND DOUBLE ROW STRIPS

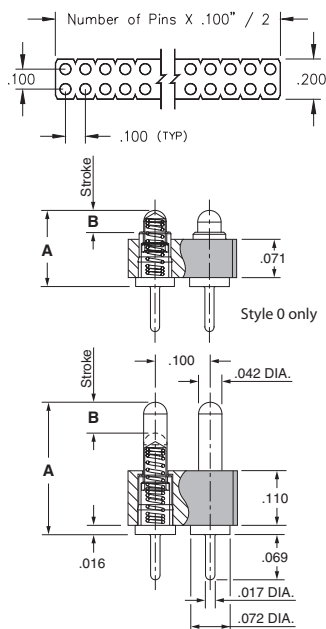


- Modular contacts for use on .100" grid, available in five heights from .137" to .236", supplied in single and double row contact strips
- Precision-machined piston / base and gold-plated components assure up to 1,000,000 cycle life durability
- Pistons have a long stroke relative to the low profile of the assembly
- Low resistance, high current contacts are rated at 2 amps continuous, 3 amps peak
- High temperature thermoplastic insulators are suitable for surface mount processes
- Both 821 & 823 series contact strips are designed for manual placement into  $\varnothing .030" \pm .003"$  plated through-holes in the circuit board prior to hand, wave or reflow soldering

### SINGLE ROW Series 821



### DOUBLE ROW Series 823



## ORDERING INFORMATION

### Single Row Series 821

821-22-0XX-10-00X101

Specify number of contacts 02-64      Specify contact style 0-4

### Double Row Series 823

823-22-0XX-10-00X101

Specify number of contacts 04-72      Specify contact style 0-4

CONTACT STYLE	INITIAL HEIGHT A	MAX. STROKE B
0	.137	.039
1	.177	.045
2	.197	.055
3	.217	.055
4	.236	.055

## Technical Specifications

### Materials:

Contact piston & base: Machined copper alloy plated 20 $\mu$ " gold over 100 $\mu$ " nickel  
 Spring: Beryllium copper-plated 10 $\mu$ " gold  
 Insulator: High temperature thermoplastic, rated UL94 V-0

### Mechanical:

Spring force @ initial height (A): 25 grams  
 Spring force @ mid stroke (B/2): 60 grams  
 Durability: Up to 1,000,000 cycles

### Electrical:

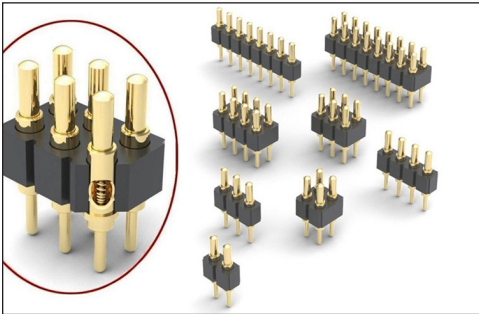
Voltage rating: 100Vrms/150Vdc  
 Current rating: 2A (continuous), 3A (peak) per contact  
 Contact resistance: 20m $\Omega$  max.  
 Insulation resistance: 10,000M $\Omega$  min.  
 Dielectric strength: 700Vrms min.  
 Capacitance: 1pF max.

RoHS - 2  
2011/65/EU



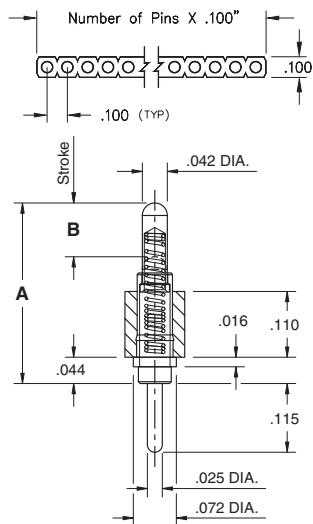
# SPRING-LOADED CONNECTORS

## SERIES 825 & 827 • .100" GRID THROUGH-HOLE MOUNT, LONG STROKE • SINGLE AND DOUBLE ROW STRIPS

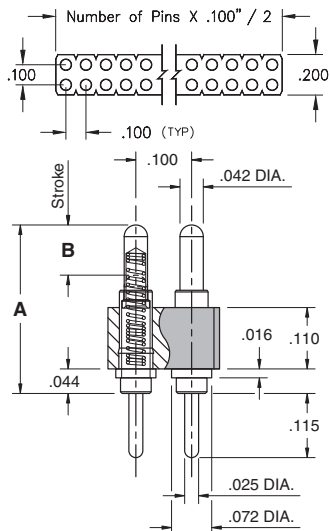


- Modular contacts for use on .100" grid, available in four heights from .302" to .392", supplied in single and double row contact strips
- Precision-machined piston / base and gold-plated components assure up to 1,000,000 cycle life durability
- Pistons have a .045" mid. stroke and a .090" max. stroke
- Low resistance, high current contacts are rated at 2 amps continuous, 3 amps peak
- High temperature thermoplastic insulators are suitable for surface mount processes
- Both 825 & 827 series contact strips are designed for manual placement into  $\varnothing .038" \pm .003"$  plated through-holes in the circuit board prior to hand, wave or reflow soldering

### SINGLE ROW Series 825



### DOUBLE ROW Series 827



## ORDERING INFORMATION

### Single Row Series 825

825-22-0XX-10-00X101  
 Specify number of contacts 02-64      Specify contact style 1-4

### Double Row Series 827

827-22-0XX-10-00X101  
 Specify number of contacts 04-72      Specify contact style 1-4

CONTACT STYLE	INITIAL HEIGHT A	MAX. STROKE B
1	.302	.090
2	.332	.090
3	.362	.090
4	.392	.090

### Technical Specifications

#### Materials:

Contact piston & base: Machined copper alloy plated 20 $\mu$ " gold over 100 $\mu$ " nickel  
 Spring: Beryllium copper-plated 10 $\mu$ " gold  
 Insulator: High temperature thermoplastic, rated UL94 V-0

#### Mechanical:

Spring force @ initial height (A): 25 grams  
 Spring force @ mid stroke (B/2): 60 grams  
 Durability: Up to 1,000,000 cycles

#### Electrical:

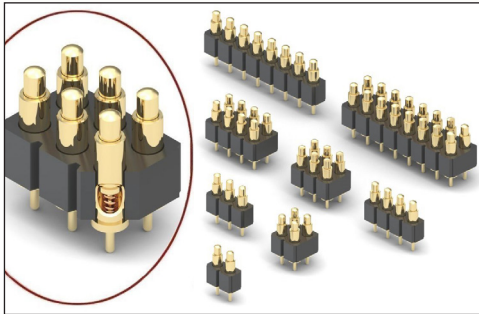
Voltage rating: 100Vrms/150Vdc  
 Current rating: 2A (continuous), 3A (peak) per contact  
 Contact resistance: 20m $\Omega$  max.  
 Insulation resistance: 10,000M $\Omega$  min.  
 Dielectric strength: 700Vrms min.  
 Capacitance: 1pF max.

RoHS-2  
2011/65/EU



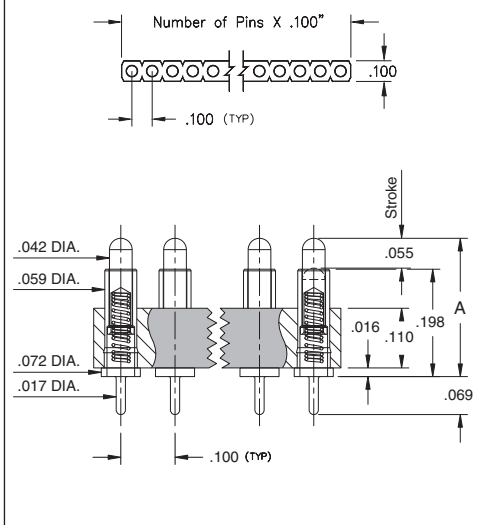
# SPRING-LOADED CONNECTORS

## SERIES 816 & 818 • .100" GRID THROUGH-HOLE MOUNT, MID PROFILE • SINGLE AND DOUBLE ROW STRIPS



- Modular contacts for use on .100" grid, available in ten heights from .255" to .430", supplied in single and double row contact strips
- Precision-machined piston / base and gold-plated components assure up to 1,000,000 cycle life durability
- Pistons have a .0275" mid stroke & .055" max. stroke
- Low resistance, high current contacts are rated at 2 amps continuous, 3 amps peak
- High temperature thermoplastic insulators are suitable for surface mount processes
- Both 816 & 818 series contact strips are designed for manual placement into  $\varnothing .030" \pm .003"$  plated through-holes in the circuit board prior to intrusive reflow soldering

### SINGLE ROW Series 816...00X101



## ORDERING INFORMATION

### Single Row Series 816...00X101

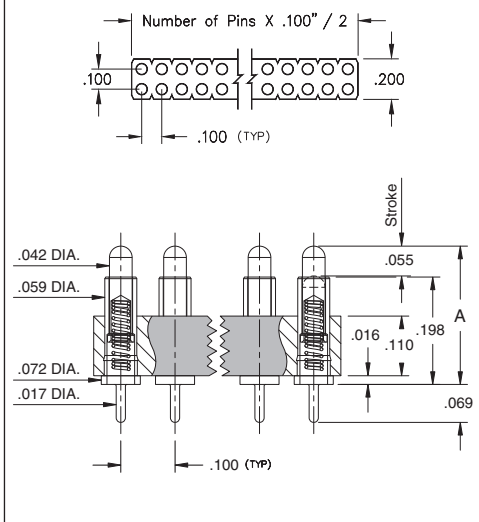
816-22-0XX-10-00X101  
 Specify number of contacts 02-64      Specify contact style 0-9

### Double Row Series 818...00X101

818-22-0XX-10-00X101  
 Specify number of contacts 04-72      Specify contact style 0-9

CONTACT STYLE	INITIAL HEIGHT A	CONTACT STYLE	INITIAL HEIGHT A
0	.255	5	.350
1	.275	6	.370
2	.295	7	.390
3	.315	8	.410
4	.335	9	.430

### DOUBLE ROW Series 818...00X101



### Technical Specifications

#### Materials:

Contact piston & base: Machined copper alloy plated 20 $\mu$ " gold over 100 $\mu$ " nickel  
 Spring: Beryllium copper-plated 10 $\mu$ " gold  
 Insulator: High temperature thermoplastic, rated UL94 V-0

#### Mechanical:

Spring force @ initial height (A): 25 grams  
 Spring force @ mid stroke (.0275"): 60 grams  
 Durability: Up to 1,000,000 cycles

#### Electrical:

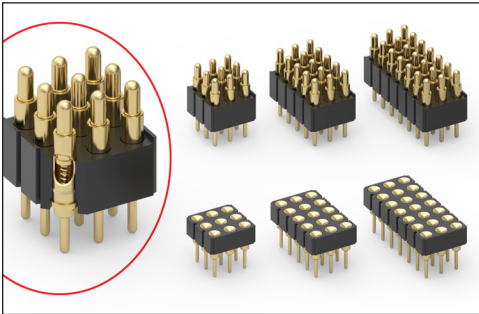
Voltage rating: 100Vrms/150Vdc  
 Current rating: 2A (continuous), 3A (peak) per contact  
 Contact resistance: 20m $\Omega$  max.  
 Insulation resistance: 10,000M $\Omega$  min.  
 Dielectric strength: 700Vrms min.  
 Capacitance: 1pF max.

RoHS - 2  
2011/65/EU



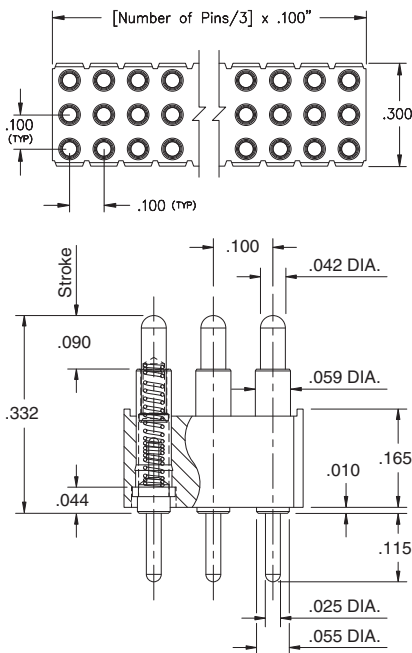
# SPRING-LOADED CONNECTORS

## SERIES 804 & 805 • .100" GRID THROUGH-HOLE MOUNT • LONG STROKE TRIPLE ROW STRIPS AND MATING TARGET CONNECTORS

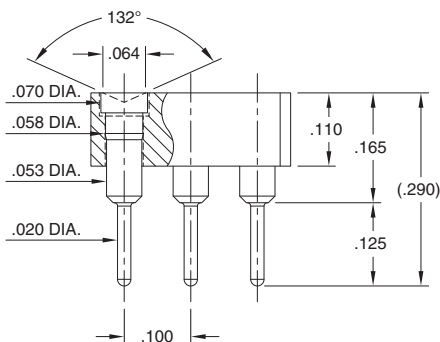


- Modular contacts for use on .100" grid, supplied in triple row contact strips
- Precision-machined piston / base and gold-plated components assure up to 1,000,000 cycle life durability
- Spring pins have a .045" mid. stroke and a .090" max. stroke
- Low resistance, high current contacts are rated at 2 amps continuous, 3 amps peak
- 804 & 805 series High temperature thermoplastic insulators are suitable for wave and reflow processes
- 804 series contact strips are designed for manual placement into Ø .038"±.003" plated through-holes in the circuit board prior to hand, wave or reflow soldering
- 805 series Target Connectors provide an excellent gold-plated conductive mating surface for spring loaded connectors. This series is offered with a concave face for making contact with our standard .042" dia. spring pin plungers

### TRIPLE ROW Series 804



### TRIPLE ROW Series 805



## ORDERING INFORMATION

### Triple Row Series 804

804-22-0XX-10-004101

Specify number of contacts 09-96

### Triple Row Mating Target Series 805

805-10-0XX-00-006000

Specify number of contacts 09-96

### Technical Specifications for 804 Series

#### Materials:

Contact piston & base: Machined copper alloy plated 20μ" gold over 100μ" nickel  
 Spring: Beryllium copper-plated 10μ" gold  
 Insulator: High temperature thermoplastic, rated UL94 V-0

#### Mechanical:

Spring force @ initial height: 25 grams  
 Spring force @ mid stroke (.045"): 60 grams  
 Durability: Up to 1,000,000 cycles

#### Electrical:

Voltage rating: 100Vrms/150Vdc  
 Current rating: 2A (continuous), 3A (peak) per contact  
 Contact resistance: 20mΩ max.  
 Insulation resistance: 10,000MΩ min.  
 Dielectric strength: 700Vrms min.  
 Capacitance: 1pF max.

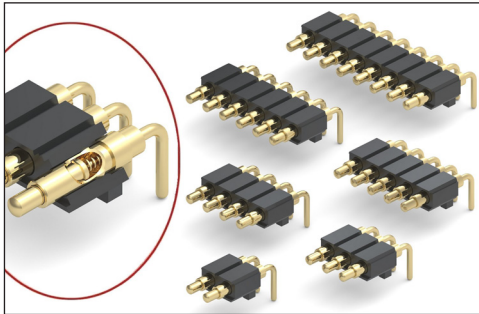
RoHS-2  
2011/65/EU





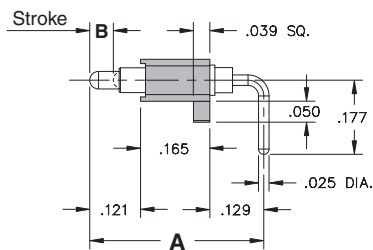
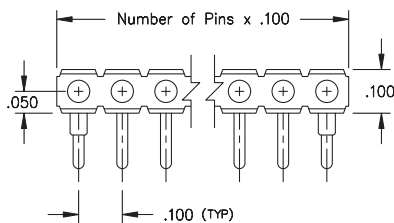
# SPRING-LOADED CONNECTORS

## SERIES 829 • .100" GRID RIGHT ANGLE MOUNT • SINGLE ROW STRIPS

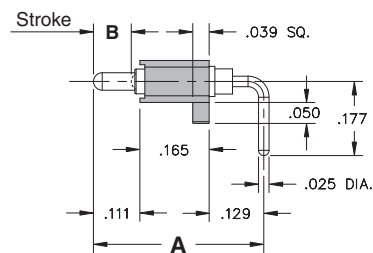


- Modular contacts for use on .100" grid. Supplied in single row strips with mounting pegs for support
- Precision-machined piston / base and gold-plated components assure up to 1,000,000 cycle life durability
- Low resistance, high current contacts are rated at 2 amps continuous, 3 amps peak
- High temperature thermoplastic insulators are suitable for wave and reflow processes
- 829 series contact strips are designed for manual placement into  $\varnothing .037" \pm .003"$  plated through-holes in the circuit board prior to wave or reflow soldering

### SINGLE ROW Series 829

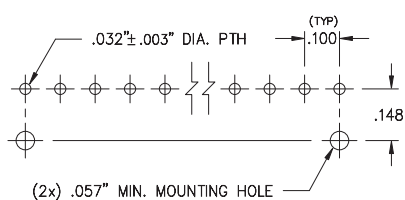


Contact style 1 only



Contact style 2 only

### Suggested P.C.B Footprint



## ORDERING INFORMATION

### Single Row Series 829

829-22-0XX-20-00X101

Specify number of contacts 01-20

Specify contact style 1 or 2

CONTACT STYLE	INITIAL LENGTH A	MAX. STROKE B
1	.415	.055
2	.406	.090

## Technical Specifications

### Materials:

Contact piston & base: Machined copper alloy plated  $20\mu$ " gold over  $100\mu$ " nickel  
 Spring: Beryllium copper-plated  $10\mu$ " gold  
 Insulator: High temperature thermoplastic, rated UL94 V-0

### Mechanical:

Spring force @ initial length (A): 25 grams  
 Spring force @ mid stroke (B/2): 60 grams  
 Durability: Up to 1,000,000 cycles

### Electrical:

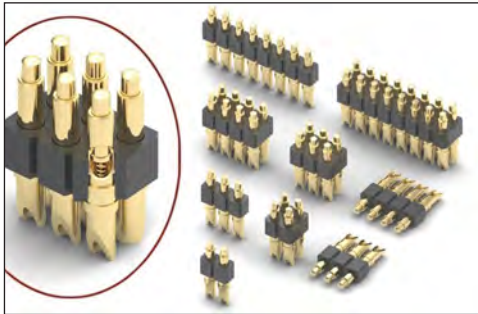
Voltage rating: 100Vrms/150Vdc  
 Current rating: 2A (continuous), 3A (peak) per contact  
 Contact resistance:  $20m\Omega$  max.  
 Insulation resistance:  $10,000M\Omega$  min.  
 Dielectric strength: 700Vrms min.  
 Capacitance: 1pF max.

RoHS - 2  
2011/65/EU



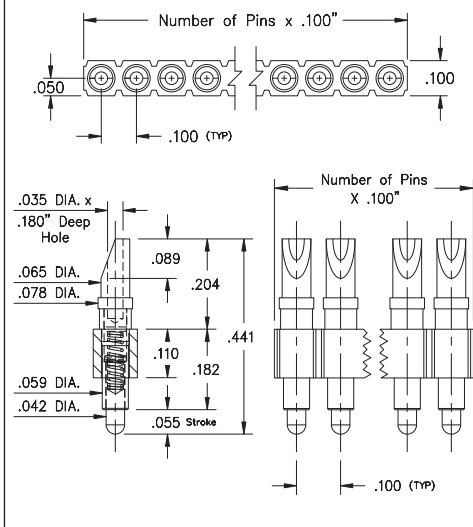
# SPRING-LOADED CONNECTORS

## SERIES 824 & 826 • .100" GRID SOLDERCUP HEADER • SINGLE AND DOUBLE ROW STRIPS

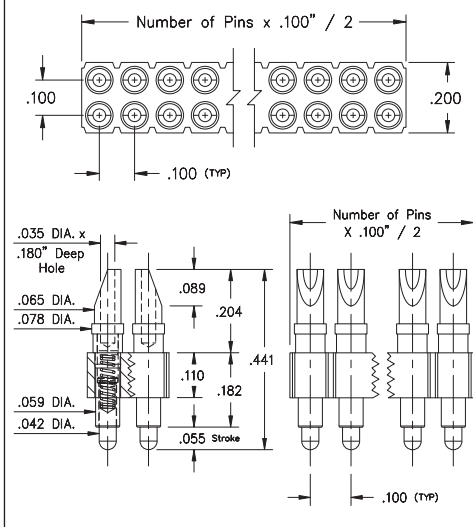


- Modular contacts for use on .100" grid, supplied in single and double row contact strips
- Precision-machined piston / base and gold-plated components assure up to 1,000,000 cycle life durability
- Pistons have a .0275" mid. stroke and a .055" max. stroke
- Low resistance, high current contacts are rated at 2 amps continuous, 3 amps peak
- Insulators are high temperature thermoplastic
- Both 824 & 826 series strips have spring pins with wire termination soldercups. The soldercups are aligned to provide easy access for soldering up to size 22 AWG wires

### SINGLE ROW Series 824



### DOUBLE ROW Series 826



## ORDERING INFORMATION

### Single Row Series 824

824-22-0XX-00-001000

Specify number of contacts 01-64

### Double Row Series 826

826-22-0XX-00-001000

Specify number of contacts 04-72

## Technical Specifications

### Materials:

Contact piston & base: Machined copper alloy plated 20 $\mu$ " gold over 100 $\mu$ " nickel  
 Spring: Beryllium copper-plated 10 $\mu$ " gold  
 Insulator: High temperature thermoplastic, rated UL94 V-0

### Mechanical:

Spring force @ initial height: 25 grams  
 Spring force @ mid stroke (.0275"): 60 grams  
 Durability: Up to 1,000,000 cycles

### Electrical:

Voltage rating: 100Vrms/150Vdc  
 Current rating: 2A (continuous), 3A (peak) per contact  
 Contact resistance: 20m $\Omega$  max.  
 Insulation resistance: 10,000M $\Omega$  min.  
 Dielectric strength: 700Vrms min.  
 Capacitance: 1pF max.

RoHS - 2  
2011/65/EU



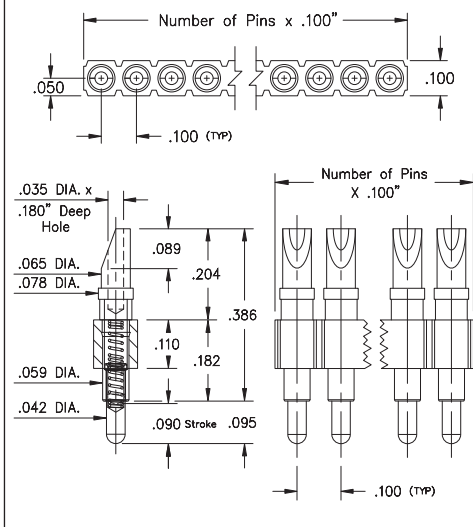
# SPRING-LOADED CONNECTORS

## SERIES 824 & 826 • .100" GRID SOLDERCUP HEADER • SINGLE AND DOUBLE ROW STRIPS

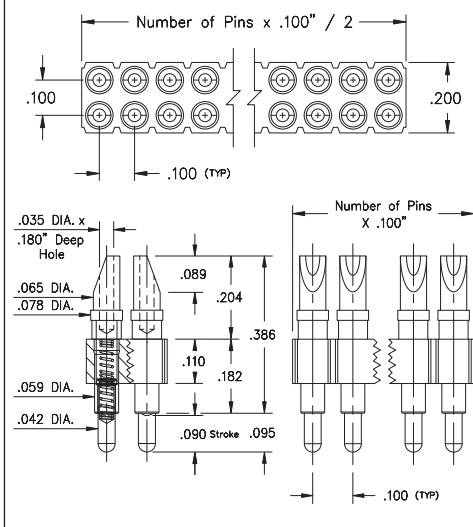


- Modular contacts for use on .100" grid, supplied in single and double row contact strips
- Precision-machined piston / base and gold-plated components assure up to 1,000,000 cycle life durability
- Pistons have a .045" mid. stroke and a .090" max. stroke
- Low resistance, high current contacts are rated at 2 amps continuous, 3 amps peak
- Insulators are high temperature thermoplastic
- Both 824 & 826 series strips have spring pins with wire termination soldercups. The soldercups are aligned to provide easy access for soldering up to size 24 AWG wires

### SINGLE ROW Series 824



### DOUBLE ROW Series 826



## ORDERING INFORMATION

### Single Row Series 824

824-22-0XX-00-005000

Specify number of contacts 01-64

### Double Row Series 826

826-22-0XX-00-005000

Specify number of contacts 02-72

## Technical Specifications

### Materials:

Contact piston & base: Machined copper alloy plated 20 $\mu$ " gold over 100 $\mu$ " nickel  
 Spring: Beryllium copper-plated 10 $\mu$ " gold  
 Insulator: High temperature thermoplastic, rated UL94 V-0

### Mechanical:

Spring force @ initial height: 25 grams  
 Spring force @ mid stroke (.045"): 60 grams  
 Durability: Up to 1,000,000 cycles

### Electrical:

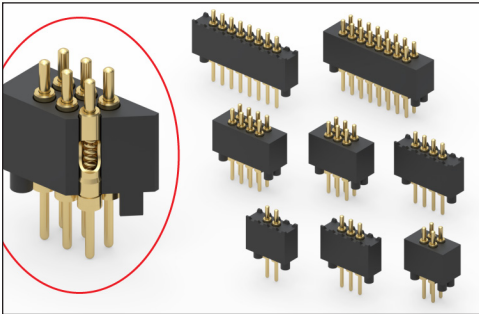
Voltage rating: 100Vrms/150Vdc  
 Current rating: 2A (continuous), 3A (peak) per contact  
 Contact resistance: 20m $\Omega$  max.  
 Insulation resistance: 10,000M $\Omega$  min.  
 Dielectric strength: 700Vrms min.  
 Capacitance: 1pF max.

RoHS-2  
2011/65/EU



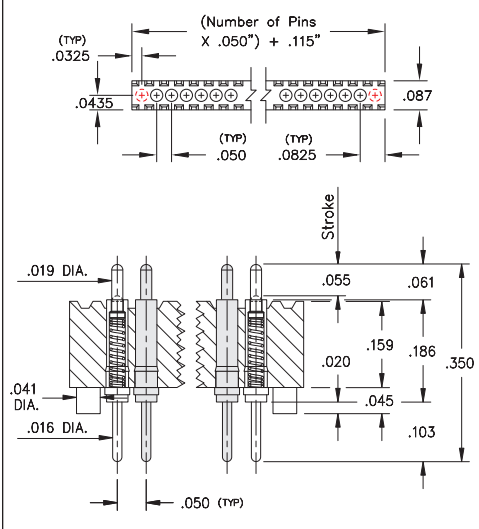
# SPRING-LOADED CONNECTORS

## SERIES 854 & 855 • .050" GRID THROUGH-HOLE MOUNT • SINGLE AND DOUBLE ROW STRIPS

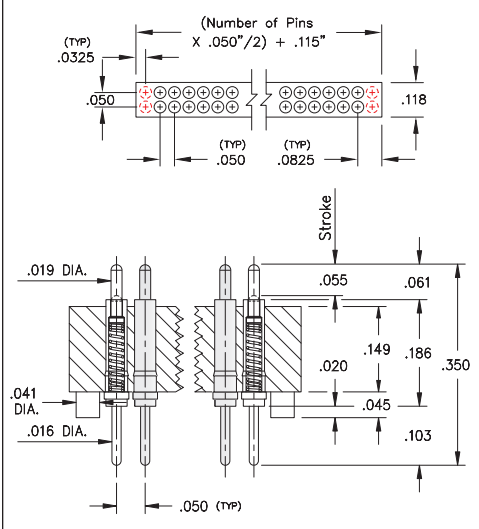


- Modular contacts for use on .050" grid, supplied in single and double row contact strips
- Precision-machined piston / base and gold-plated components assure up to 100,000 cycle life durability
- Pistons have a .0275" mid. stroke and a .055" max. stroke
- Low resistance, high current contacts are rated at 2 amps continuous, 3 amps peak
- High temperature thermoplastic insulators are suitable for wave and reflow processes
- Both 854 & 855 series contact strips are designed for manual placement into  $\varnothing .025" \pm .003"$  plated through-holes in the circuit board prior to hand, wave or reflow soldering

### SINGLE ROW Series 854



### DOUBLE ROW Series 855



## ORDERING INFORMATION

### Single Row Series 854

854-22-0XX-10-001101

Specify number of contacts 02-20

### Double Row Series 855

855-22-0XX-10-001101

Specify number of contacts 04-40

## Technical Specifications

### Materials:

Contact piston & base: Machined copper alloy plated 20 $\mu$ " gold over 100 $\mu$ " nickel  
 Spring: Beryllium copper-plated 10 $\mu$ " gold  
 Insulator: High temperature thermoplastic, rated UL94 V-0

### Mechanical:

Spring force @ initial height: 25 grams  
 Spring force @ mid stroke (.0275"): 60 grams  
 Durability: Up to 100,000 cycles

### Electrical:

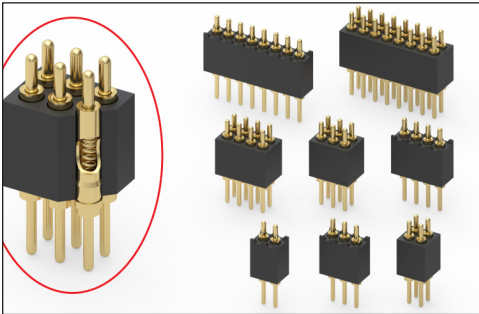
Voltage rating: 100Vrms/150Vdc  
 Current rating: 2A (continuous), 3A (peak) per contact  
 Contact resistance: 20m $\Omega$  max.  
 Insulation resistance: 10,000M $\Omega$  min.  
 Dielectric strength: 700Vrms min.  
 Capacitance: 1pF max.

RoHS-2  
2011/65/EU



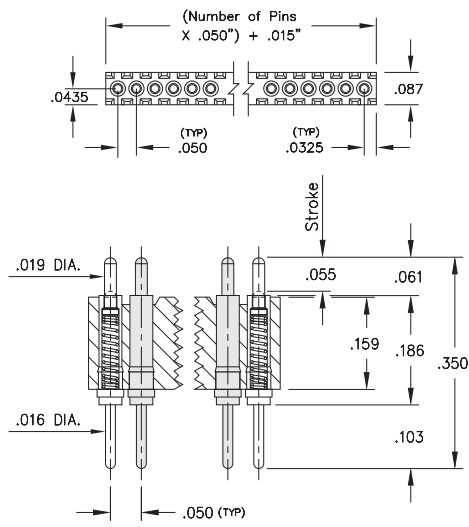
# SPRING-LOADED CONNECTORS

## SERIES 854 & 855 • .050" GRID THROUGH-HOLE MOUNT • SINGLE AND DOUBLE ROW STRIPS WITHOUT STANDOFFS

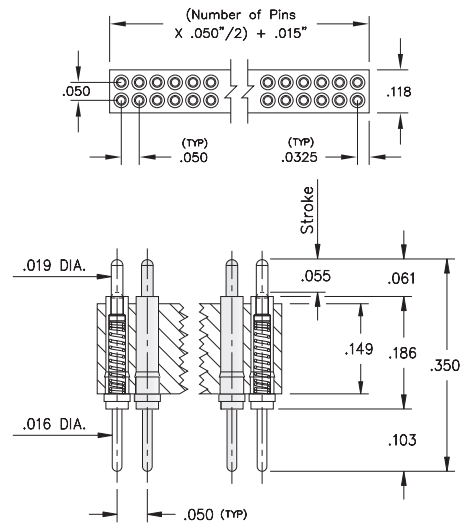


- Modular contacts for use on .050" grid, supplied in single and double row contact strips
- Precision-machined piston / base and gold-plated components assure up to 100,000 cycle life durability
- Pistons have a .0275" mid. stroke and a .055" max. stroke
- Low resistance, high current contacts are rated at 2 amps continuous, 3 amps peak
- High temperature thermoplastic insulators are suitable for wave and reflow processes
- Both 854 & 855 series contact strips are designed for manual placement into  $\varnothing .025" \pm .003"$  plated through-holes in the circuit board prior to hand, wave or reflow soldering

### SINGLE ROW Series 854



### DOUBLE ROW Series 855



## ORDERING INFORMATION

### Single Row Series 854

854-22-0XX-10-002101

Specify number of contacts 02-20

### Double Row Series 855

855-22-0XX-10-002101

Specify number of contacts 04-40

## Technical Specifications

### Materials:

Contact piston & base: Machined copper alloy plated  $20\mu$ " gold over  $100\mu$ " nickel  
 Spring: Beryllium copper-plated  $10\mu$ " gold  
 Insulator: High temperature thermoplastic, rated UL94 V-0

### Mechanical:

Spring force @ initial height: 25 grams  
 Spring force @ mid stroke (.0275"): 60 grams  
 Durability: Up to 100,000 cycles

### Electrical:

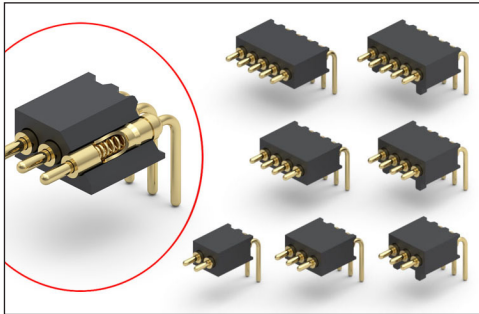
Voltage rating: 100Vrms/150Vdc  
 Current rating: 2A (continuous), 3A (peak) per contact  
 Contact resistance:  $20m\Omega$  max.  
 Insulation resistance:  $10,000M\Omega$  min.  
 Dielectric strength: 700Vrms min.  
 Capacitance: 1pF max.

RoHS-2  
2011/65/EU



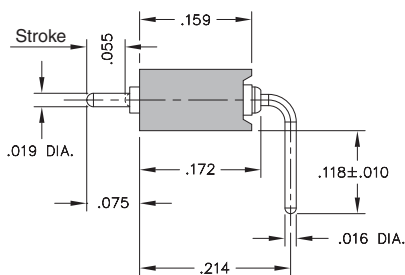
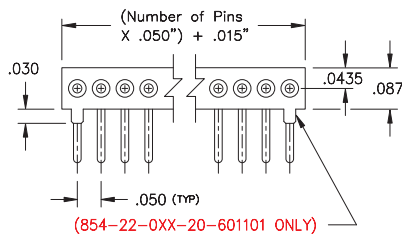
# SPRING-LOADED CONNECTORS

## SERIES 854 • .050" GRID RIGHT ANGLE MOUNT • SINGLE ROW STRIPS

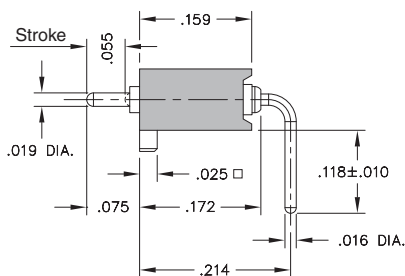


- Modular contacts for use on .050" grid. Supplied in single row strips with or without mounting pegs
- Precision-machined piston / base and gold-plated components assure up to 100,000 cycle life durability
- Pistons have a .0275" mid. stroke & .055" max. stroke
- Low resistance, high current contacts are rated at 2 amps continuous, 3 amps peak
- High temperature thermoplastic insulators are suitable for wave and reflow soldering processes
- 854 series contact strips are designed for through-hole mounting in the circuit board

### SINGLE ROW Series 854

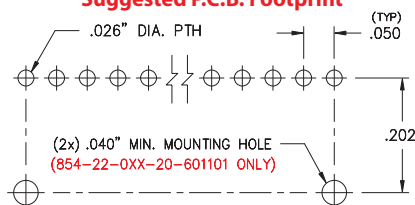


### 854 Series without Mounting Pegs



### 854 Series with Mounting Pegs

### Suggested P.C.B. Footprint



## ORDERING INFORMATION

### Single Row Series 854

854-22-0XX-20-001101

Specify number of contacts 01-20

### Single Row with Mounting Pegs Series 854

854-22-0XX-20-601101

Specify number of contacts 01-20

## Technical Specifications

### Materials:

Contact piston & base: Machined copper alloy plated 20μ" gold over 100μ" nickel  
 Spring: Beryllium copper-plated 10μ" gold  
 Insulator: High temperature thermoplastic, rated UL94 V-0

### Mechanical:

Spring force @ initial height: 25 grams  
 Spring force @ mid stroke (.0275"): 60 grams  
 Durability: Up to 100,000 cycles

### Electrical:

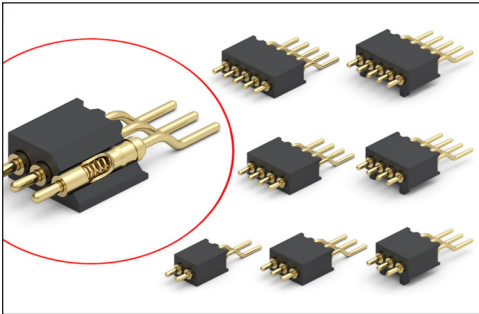
Voltage rating: 100Vrms/150Vdc  
 Current rating: 2A (continuous), 3A (peak) per contact  
 Contact resistance: 20mΩ max.  
 Insulation resistance: 10,000MΩ min.  
 Dielectric strength: 700Vrms min.  
 Capacitance: 1pF max.

RoHS-2  
2011/65/EU



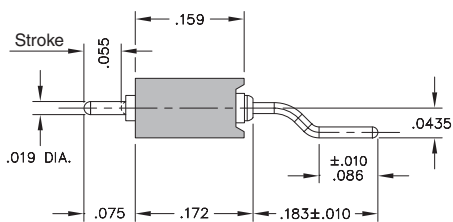
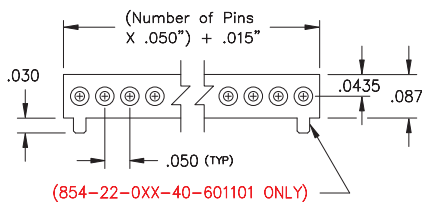
# SPRING-LOADED CONNECTORS

## SERIES 854 • .050" GRID Z-BEND SURFACE MOUNT • SINGLE ROW STRIPS

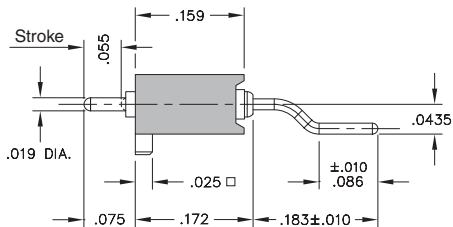


- Modular contacts for use on .050" grid, supplied in single row contact strips. Piston action is parallel to the board surface
- Precision-machined piston / base and gold-plated components assure up to 100,000 cycle life durability
- Pistons have a .0275" mid. stroke & .055" max. stroke
- Low resistance, high current contacts are rated at 2 amps continuous, 3 amps peak
- High temperature thermoplastic insulators are suitable for surface mount soldering processes
- 854 series contact strips are designed for SMT termination onto printed circuit boards

### SINGLE ROW Series 854



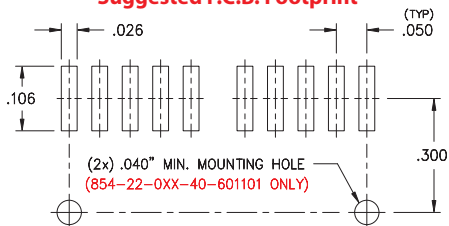
**854 Series without Mounting Pegs**



**854 Series with Mounting Pegs**

Coplanarity .005". For pin counts >20 positions, consult Technical Support.

### Suggested P.C.B. Footprint



## ORDERING INFORMATION

### Series 854 without Mounting Pegs (Bulk Packaged)

854-22-0XX-40-001101

Specify number of contacts 01-20

### Series 854 with Mounting Pegs (Bulk Packaged)

854-22-0XX-40-601101

Specify number of contacts 01-20

### Series 854 with Mounting Pegs (Tape & Reel Packaged, 2,400 parts per reel)

854-22-0XX-40-601191

Specify number of contacts 02

## Technical Specifications

### Materials:

Contact piston & base: Machined copper alloy plated 20μ" gold over 100μ" nickel  
 Spring: Beryllium copper-plated 10μ" gold  
 Insulator: High temperature thermoplastic, rated UL94 V-0

### Mechanical:

Spring force @ initial height: 25 grams  
 Spring force @ mid stroke (.0275"): 60 grams  
 Durability: Up to 100,000 cycles

### Electrical:

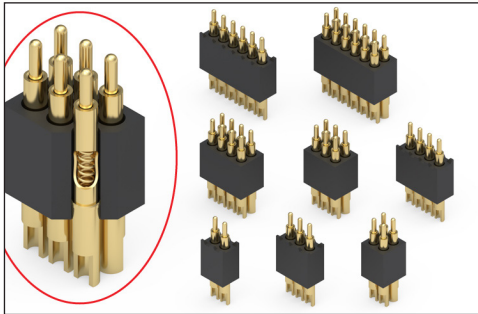
Voltage rating: 100Vrms/150Vdc  
 Current rating: 2A (continuous), 3A (peak) per contact  
 Contact resistance: 20mΩ max.  
 Insulation resistance: 10,000MΩ min.  
 Dielectric strength: 700Vrms min.  
 Capacitance: 1pF max.

RoHS-2  
2011/65/EU



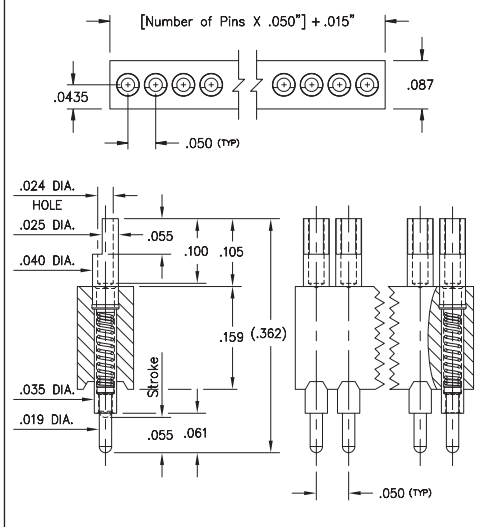
# SPRING-LOADED CONNECTORS

## SERIES 854 & 855 • .050" GRID SOLDERCUP HEADER • SINGLE AND DOUBLE ROW STRIPS

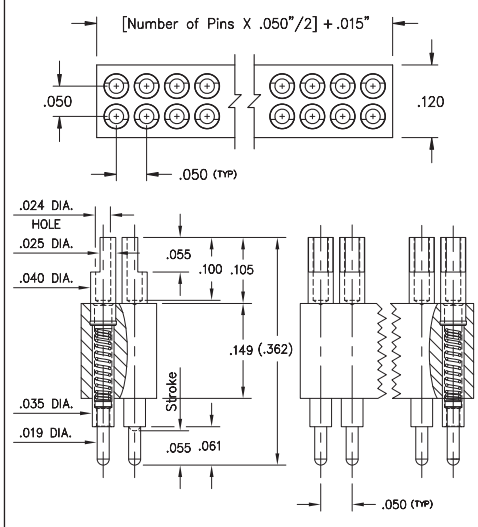


- Modular contacts for use on .050" grid, supplied in single and double row contact strips
- Precision-machined piston / base and gold-plated components assure up to 100,000 cycle life durability
- Pistons have a .0275" mid. stroke and a .055" max. stroke
- Low resistance, high current contacts are rated at 2 amps continuous, 3 amps peak
- Insulators are high temperature thermoplastic
- Both 854 & 855 series strips have spring pins with wire termination soldercups. The soldercups are aligned to provide easy access for soldering up to size 26 AWG wires

### SINGLE ROW Series 854



### DOUBLE ROW Series 855



## ORDERING INFORMATION

### Single Row Series 854

854-22-0XX-10-003101

Specify number of contacts 01-50

### Double Row Series 855

855-22-0XX-10-003101

Specify number of contacts 02-100

## Technical Specifications

### Materials:

Contact piston & base: Machined copper alloy plated 20μ" gold over 100μ" nickel  
 Spring: Beryllium copper-plated 10μ" gold  
 Insulator: High temperature thermoplastic, rated UL94 V-0

### Mechanical:

Spring force @ initial height: 25 grams  
 Spring force @ mid stroke (.0275"): 60 grams  
 Durability: Up to 100,000 cycles

### Electrical:

Voltage rating: 100Vrms/150Vdc  
 Current rating: 2A (continuous), 3A (peak) per contact  
 Contact resistance: 20mΩ max.  
 Insulation resistance: 10,000MΩ min.  
 Dielectric strength: 700Vrms min.  
 Capacitance: 1pF max.

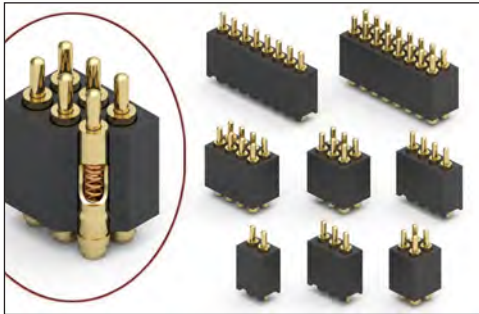
RoHS-2  
2011/65/EU





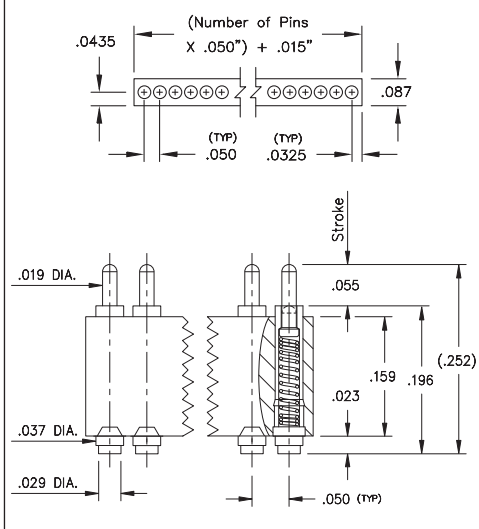
# SPRING-LOADED CONNECTORS

## SERIES 854 & 855 • .050" GRID SURFACE MOUNT, HIGH DENSITY • SINGLE AND DOUBLE ROW STRIPS

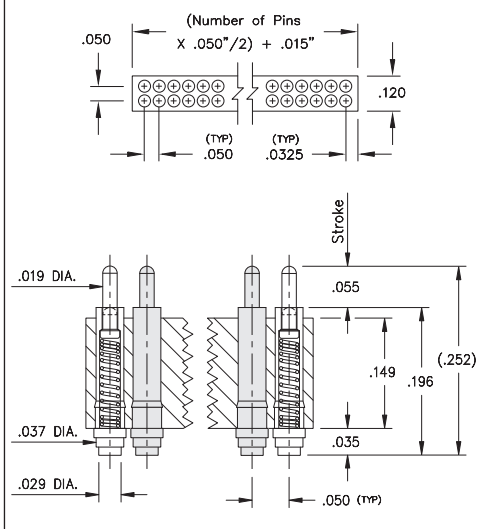


- Modular contacts for use on .050" grid, supplied in single and double row contact strips
- Precision-machined piston / base and gold-plated components assure up to 100,000 cycle life durability
- Pistons have a .0275" mid. stroke and a .055" max. stroke
- Low resistance, high current contacts are rated at 2 amps continuous, 3 amps peak
- High temperature thermoplastic insulators are suitable for surface mount processes
- 854 & 855 series contact strips are designed for manual placement onto .040" Ø solder pads
- 855 series is also available on tape & reel packaging, see page 19.1

### SINGLE ROW Series 854



### DOUBLE ROW Series 855



## ORDERING INFORMATION

### Single Row Series 854

854-22-0XX-30-001101

Specify number of contacts 02-20

### Double Row Series 855

855-22-0XX-30-001101

Specify number of contacts 04-40

For 855 Tape & Reel packaging, see page 19.1

## Technical Specifications

### Materials:

Contact piston & base: Machined copper alloy plated  $20\mu$ " gold over  $100\mu$ " nickel  
 Spring: Beryllium copper-plated  $10\mu$ " gold  
 Insulator: High temperature thermoplastic, rated UL94 V-0

### Mechanical:

Spring force @ initial height: 25 grams  
 Spring force @ mid stroke (.0275"): 60 grams  
 Durability: Up to 100,000 cycles

### Electrical:

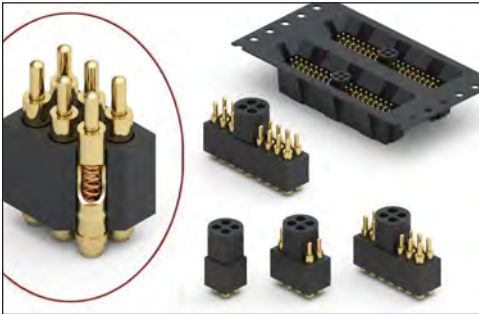
Voltage rating: 100Vrms/150Vdc  
 Current rating: 2A (continuous), 3A (peak) per contact  
 Contact resistance:  $20m\Omega$  max.  
 Insulation resistance:  $10,000M\Omega$  min.  
 Dielectric strength: 700Vrms min.  
 Capacitance: 1pF max.

RoHS-2  
2011/65/EU



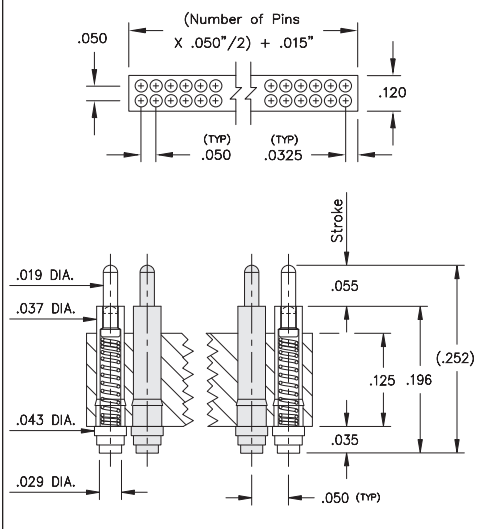
# SPRING-LOADED CONNECTORS

## SERIES 855 • .050" GRID SURFACE MOUNT, HIGH DENSITY • DOUBLE ROW STRIPS ON TAPE & REEL

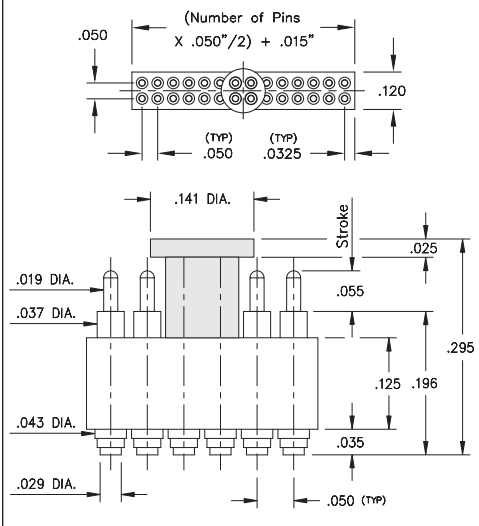


- Modular contacts for use on .050" grid, supplied in single and double row contact strips
- Precision-machined piston / base and gold-plated components assure up to 100,000 cycle life durability
- Pistons have a .0275" mid. stroke and a .055" max. stroke
- Low resistance, high current contacts are rated at 2 amps continuous, 3 amps peak
- High temperature thermoplastic insulators are suitable for surface mount processes
- 855 series is available on carrier tape for automated pick and place assembly. Tape and Reel packaging per EIA-481. For details contact Mill-Max Technical support

### DOUBLE ROW Series 855



### Series 855 w/ removable pick n place cap



## ORDERING INFORMATION

### Double Row Series 855

855-22-0XX-30-002191

Specify number or pins  
04-40

Tape & reel packaged = 191  
660 parts per 13" reel

**Positions: 6, 10, 14, 18, 22, 26, 30, 34, 38 the Pick n Place Vacuum Cap will be offset from center by .025"**

**Positions: 4, 8, 12, 16, 20, 24, 28, 32, 36, 40 the Pick n Place Vacuum Cap will be centered**

### Technical Specifications

#### Materials:

Contact piston & base: Machined copper alloy plated 20 $\mu$ " gold over 100 $\mu$ " nickel  
Spring: Beryllium copper-plated 10 $\mu$ " gold  
Insulator: High temperature thermoplastic, rated UL94 V-0

#### Mechanical:

Spring force @ initial height: 25 grams  
Spring force @ mid stroke (.0275"): 60 grams  
Durability: Up to 100,000 cycles

#### Electrical:

Voltage rating: 100Vrms/150Vdc  
Current rating: 2A (continuous), 3A (peak) per contact  
Contact resistance: 20m $\Omega$  max.  
Insulation resistance: 10,000M $\Omega$  min.  
Dielectric strength: 700Vrms min.  
Capacitance: 1pF max.

RoHS-2  
2011/65/EU



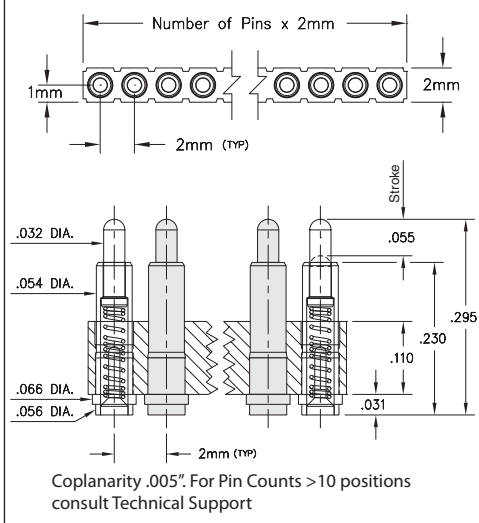
# SPRING-LOADED CONNECTORS

## SERIES 836 & 838 • 2mm GRID SURFACE MOUNT • SINGLE AND DOUBLE ROW STRIPS

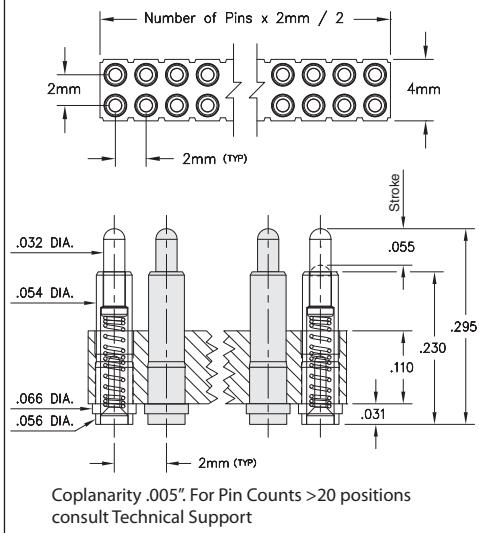


- Modular contacts for use on 2mm grid, available in single and double row contact strips with rated travel of .0275" and max. stroke of .055"
- Precision-machined piston / base and gold-plated components assure up to 1,000,000 cycle life durability
- Low resistance, high current contacts are rated at 2 amps continuous, 3 amps peak
- High temperature thermoplastic insulators are suitable for SMT soldering processes
- Both 836 & 838 series, are available on 32mm wide carrier tape and fitted with vacuum pick-up clips for automated pick and place assembly. Tape and Reel packaging per EIA-481
- 836 & 838 series contact strips are designed for manual or automatic placement onto .066" Ø solder pads

### SINGLE ROW Series 836



### DOUBLE ROW Series 838



## ORDERING INFORMATION

### Series 836 (Bulk Packaged)

836-22-0XX-30-001101

Specify number of contacts 02-10

### Series 836 (Tape & Reel Packaged, 400 parts per reel)

836-22-0XX-30-001191

Specify number of contacts 02-10

### Series 838 (Bulk Packaged)

838-22-0XX-30-001101

Specify number of contacts 04-20

### Series 838 (Tape & Reel Packaged, 400 parts per reel)

838-22-0XX-30-001191

Specify number of contacts 04-20

## Technical Specifications

### Materials:

Contact piston & base: Machined copper alloy plated 20µ" gold over 100µ" nickel

Spring: Stainless Steel-plated 10µ" gold

Insulator: High temperature thermoplastic, rated UL94 V-0

### Mechanical:

Spring force @ initial height: 25 grams

Spring force @ mid stroke (.0275"): 60 grams

Durability: Up to 1,000,000 cycles

### Electrical:

Voltage rating: 100Vrms/150Vdc

Current rating: 2A (continuous), 3A (peak) per contact

Contact resistance: 20mΩ max.

Insulation resistance: 10,000MΩ min.

Dielectric strength: 700Vrms min.

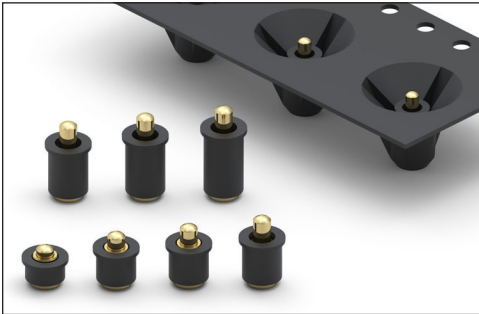
Capacitance: 1pF max.

RoHS - 2  
2011/65/EU



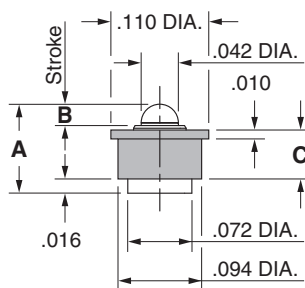
# SPRING-LOADED CONNECTORS

## SERIES 807 • DISCRETE INSULATED SPRING-LOADED PINS • SURFACE MOUNT

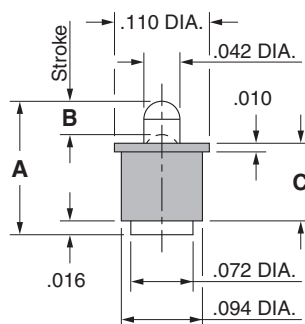


- Discrete insulated spring-loaded pins; available in seven heights from .100" to .236", with rated travel from .012" to .0275"
- Precision-machined piston / base and gold-plated components assure up to 1,000,000 cycle life durability
- Low resistance contacts are rated at 2 amps continuous, 3 amps peak
- High temperature thermoplastic insulators are suitable for SMT soldering processes
- 807 series, contact styles 0 through 6, are available in bulk or on 16mm wide carrier tape for automated pick and place assembly. Tape and Reel packaging per EIA-481. See below for ordering information

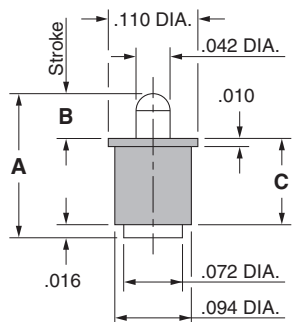
### Series 807 (Contact Style 0)



### Series 807 (Contact Style 1 & 2)



### Series 807 (Contact Style 3-6)



## ORDERING INFORMATION

### Series 807 (Bulk Packaged)

807-22-001-30-00X101

Specify contact style 0-6

### Series 807 (Tape & Reel Packaged)

807-22-001-30-00X191

Specify contact style 0-6

Contact Style	Initial Height (A)	Rated Travel	Full Stroke Range (B)	Sleeve Height (C)	Quantity per Reel
0	.100	.012	.020-.024	.055	2,620
1	.137	.0195	.030-.039	.082	1,750
2	.155	.0195	.035-.039	.090	1,750
3	.177	.0275	.045-.055	.106	1,055
4	.197	.0275	.045-.055	.126	780
5	.217	.0275	.045-.055	.146	780
6	.236	.0275	.045-.055	.165	780

### Technical Specifications

#### Materials:

Contact piston & base: Machined copper alloy plated 20 $\mu$ " gold over 100 $\mu$ " nickel  
 Spring (Contact style 0): Stainless Steel-plated 10 $\mu$ " gold  
 Spring (Contact style 1-6): Beryllium copper-plated 10 $\mu$ " gold  
 Insulator: High temperature thermoplastic, rated UL94 V-0

#### Mechanical:

Spring force @ initial height (A) (Contact style 0-6): 25 grams  
 Spring force @ mid stroke (B/2) (Contact style 0): 70 grams  
 Spring force @ mid stroke (B/2) (Contact style 1-6): 60 grams  
 Durability: Up to 1,000,000 cycles

#### Electrical:

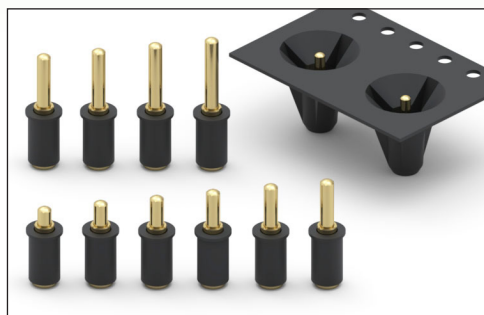
Current rating: 2A (continuous), 3A (peak) per contact  
 Contact resistance: 20m $\Omega$  max.  
 Insulation resistance: 10,000M $\Omega$  min.  
 Dielectric strength: 700Vrms min.

RoHS-2  
2011/65/EU



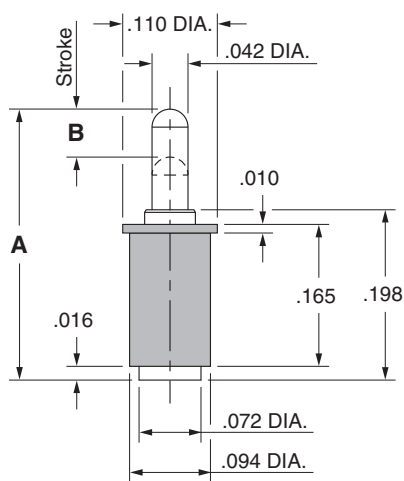
# SPRING-LOADED CONNECTORS

## SERIES 807 • DISCRETE INSULATED SPRING-LOADED PINS • SURFACE MOUNT

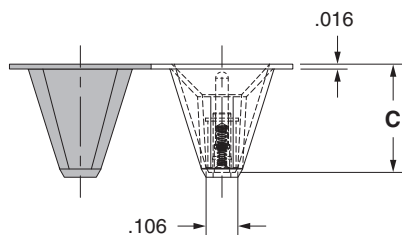


- Discrete insulated spring-loaded pins; available in ten heights from .255" to .430", with rated travel of .0275"
- Precision-machined piston / base and gold-plated components assure up to 1,000,000 cycle life durability
- Low resistance contacts are rated at 2 amps continuous, 3 amps peak
- High temperature thermoplastic insulators are suitable for most SMT soldering processes
- 807 series, contact styles 0 through 9, are available in bulk or on 16mm wide carrier tape for automated pick and place assembly. Tape and Reel packaging per EIA-481. See below for ordering information

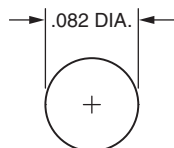
### Series 807 (Contact Style 0-9)



### Series 807 (Tape Pocket Depth)



### Series 807 (Suggested footprint layout)



## ORDERING INFORMATION

### Series 807 (Bulk Packaged)

807-22-001-30-01X101

Specify contact style 0-9

### Series 807 (Tape & Reel Packaged)

807-22-001-30-01X191

Specify contact style 0-9

Contact Style	Initial Height (A)	Rated Travel	Full Stroke Range (B)	Tape Depth (C)	Quantity per Reel
0	.255	.0275	.045-.055	.285	750
1	.275	.0275	.045-.055	.285	750
2	.295	.0275	.045-.055	.326	600
3	.315	.0275	.045-.055	.326	600
4	.335	.0275	.045-.055	.361	550
5	.350	.0275	.045-.055	.361	550
6	.370	.0275	.045-.055	.401	475
7	.390	.0275	.045-.055	.401	475
8	.410	.0275	.045-.055	.441	430
9	.430	.0275	.045-.055	.441	430

### Technical Specifications

#### Materials:

Contact piston & base: Machined copper alloy plated 20μ" gold over 100μ" nickel  
Spring (Contact style 0-9): Beryllium copper-plated 10μ" gold  
Insulator: High temperature thermoplastic, rated UL94 V-0

#### Mechanical:

Spring force @ initial height (A) (Contact style 0-9): 25 grams  
Spring force @ mid stroke (B/2) (Contact style 0-9): 60 grams  
Durability: Up to 1,000,000 cycles

#### Electrical:

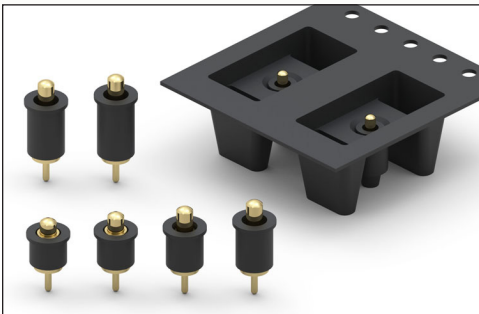
Current rating: 2A (continuous), 3A (peak) per contact  
Contact resistance: 20mΩ max.  
Insulation resistance: 10,000MΩ min.  
Dielectric strength: 700Vrms min.

RoHS-2  
2011/65/EU



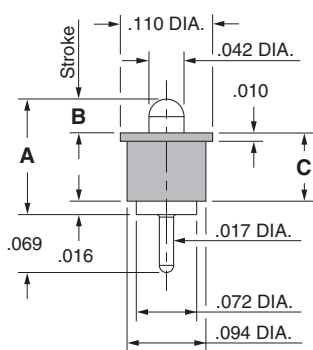
# SPRING-LOADED CONNECTORS

## SERIES 807 • DISCRETE INSULATED SPRING-LOADED PINS • THROUGH-HOLE MOUNT

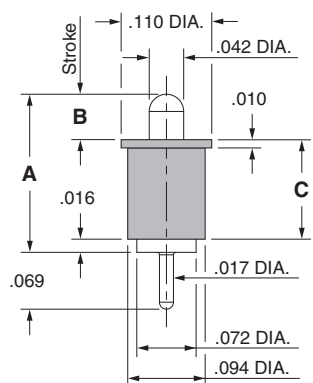


- Discrete insulated spring-loaded pins; available in six heights from .137" to .236", with rated travel of .0195" & .0275"
- Precision-machined piston / base and gold-plated components assure up to 1,000,000 cycle life durability
- Low resistance contacts are rated at 2 amps continuous, 3 amps peak
- High temperature thermoplastic insulators are suitable for most SMT soldering processes
- 807 series, contact styles 1 through 6, are available in bulk or on 24mm wide carrier tape for automated pick and place assembly. Tape and Reel packaging per EIA-481. See below for ordering information

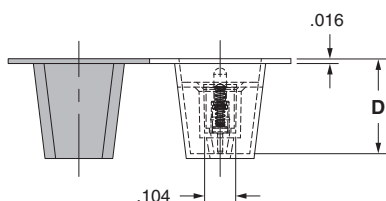
### Series 807 (Contact Style 1 & 2)



### Series 807 (Contact Style 3, 4, 5 & 6)



### Series 807 (Tape Pocket Depth)



## ORDERING INFORMATION

### Series 807 (Bulk Packaged)

807-22-001-10-00X101

Specify contact style 1-6

### Series 807 (Tape & Reel Packaged)

807-22-001-10-00X191

Specify contact style 1-6

Contact Style	Initial Height (A)	Rated Travel	Full Stroke Range (B)	Sleeve Height (C)	Tape Depth (D)	Quantity per Reel
1	.137	.0195	.030-.039	.082	.236	880
2	.155	.0195	.035-.039	.090	.236	880
3	.177	.0275	.045-.055	.106	.278	745
4	.197	.0275	.045-.055	.126	.278	745
5	.217	.0275	.045-.055	.146	.317	640
6	.236	.0275	.045-.055	.165	.317	640

### Technical Specifications

#### Materials:

Contact piston & base: Machined copper alloy plated 20μ" gold over 100μ" nickel  
Spring (Contact style 1-6): Beryllium copper-plated 10μ" gold  
Insulator: High temperature thermoplastic, rated UL94 V-0

#### Mechanical:

Spring force @ initial height (A) (Contact style 1-6): 25 grams  
Spring force @ mid stroke (B/2) (Contact style 1-6): 60 grams  
Durability: Up to 1,000,000 cycles

#### Electrical:

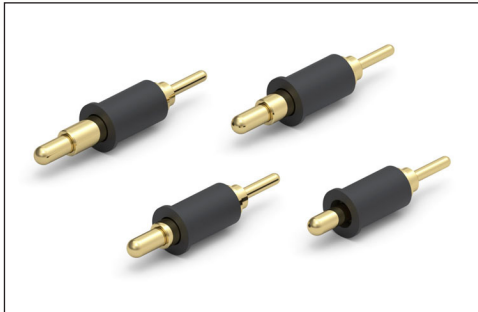
Current rating: 2A (continuous), 3A (peak) per contact  
Contact resistance: 20mΩ max.  
Insulation resistance: 10,000MΩ min.  
Dielectric strength: 700Vrms min.

RoHS-2  
2011/65/EU



# SPRING-LOADED CONNECTORS

## SERIES 807 • DISCRETE INSULATED SPRING-LOADED PINS • THROUGH-HOLE MOUNT



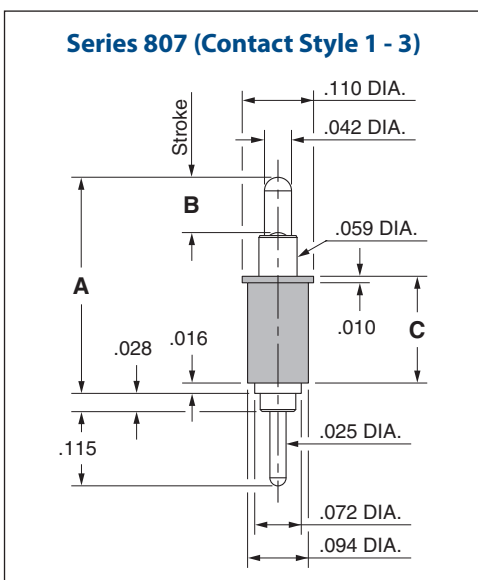
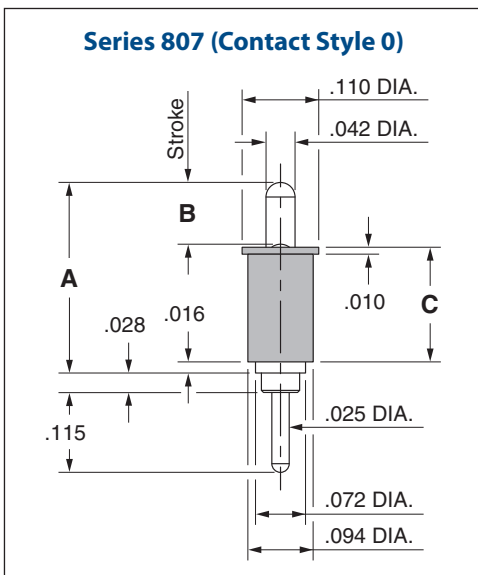
- Discrete insulated spring-loaded pins; available in four heights from .274" to .364", with rated travel of .045"
- Precision-machined piston / base and gold-plated components assure up to 1,000,000 cycle life durability
- Low resistance contacts are rated at 2 amps continuous, 3 amps peak
- High temperature thermoplastic insulators are suitable for most soldering processes
- 807 series, contact styles 0 through 3, are packaged in bulk. See below for ordering information

### ORDERING INFORMATION

#### Series 807 (Bulk Packaged)

807-22-001-10-02X101

Specify contact style 0-3



Contact Style	Initial Height (A)	Rated Travel	Full Stroke Range (B)	Sleeve Height (C)
0	.274	.045	.085-.090	.165
1	.304	.045	.085-.090	.165
2	.334	.045	.085-.090	.165
3	.364	.045	.085-.090	.165

#### Technical Specifications

##### Materials:

Contact piston & base: Machined copper alloy plated 20μ" gold over 100μ" nickel  
 Spring (Contact style 0-3): Beryllium copper-plated 10μ" gold  
 Insulator: High temperature thermoplastic, rated UL94 V-0

##### Mechanical:

Spring force @ initial height (A) (Contact style 0-3): 25 grams  
 Spring force @ mid stroke (B/2) (Contact style 0-3): 60 grams  
 Durability: Up to 1,000,000 cycles

##### Electrical:

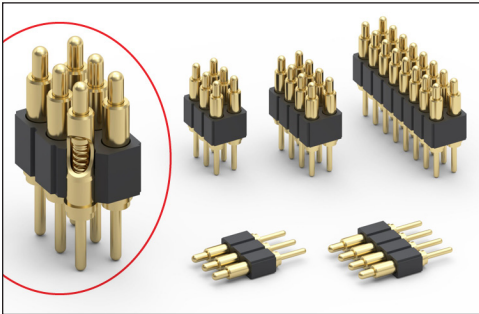
Current rating: 2A (continuous), 3A (peak) per contact  
 Contact resistance: 20mΩ max.  
 Insulation resistance: 10,000MΩ min.  
 Dielectric strength: 700Vrms min.

RoHS - 2  
2011/65/EU



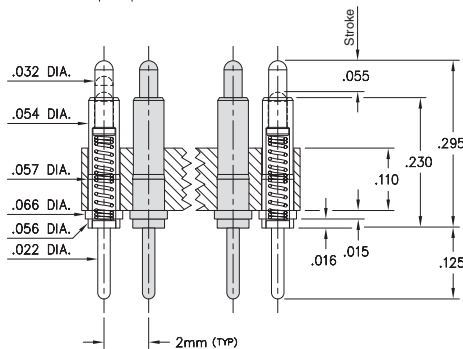
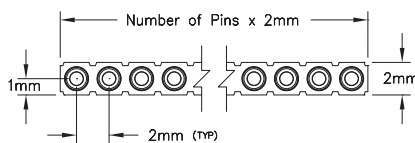
# SPRING-LOADED CONNECTORS

## SERIES 836 & 838 • 2MM GRID THROUGH-HOLE MOUNT • SINGLE AND DOUBLE ROW STRIPS

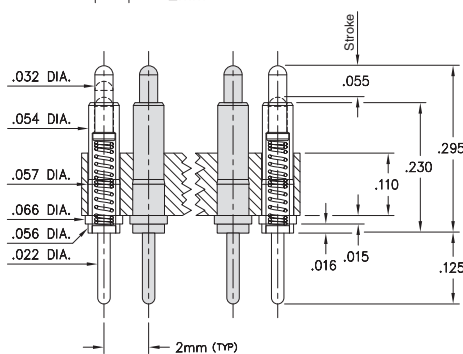
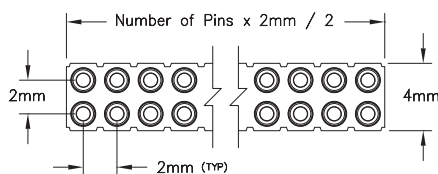


- Modular contacts for use on 2mm grid, supplied in single and double row contact strips
- Precision-machined piston / base and gold-plated components assure up to 1,000,000 cycle life durability
- Pistons have a .0275" mid. stroke and a .055" max. stroke
- Low resistance, high current contacts are rated at 2 amps continuous, 3 amps peak
- High temperature thermoplastic insulators are suitable for wave and reflow processes
- Both 836 & 838 series contact strips are designed for manual placement into  $\varnothing .033" \pm .003"$  plated through-holes in the circuit board prior to soldering

### SINGLE ROW Series 836



### DOUBLE ROW Series 838



## ORDERING INFORMATION

### Single Row Series 836

836-22-0XX-10-001101

Specify number of contacts 01-50

### Double Row Series 838

838-22-XXX-10-001101

Specify number of contacts 04-100

## Technical Specifications

### Materials:

Contact piston & base: Machined copper alloy plated 20 $\mu$ " gold over 100 $\mu$ " nickel  
 Spring: Beryllium copper-plated 10 $\mu$ " gold  
 Insulator: High temperature thermoplastic, rated UL94 V-0

### Mechanical:

Spring force @ initial height: 25 grams  
 Spring force @ mid stroke (.0275"): 60 grams  
 Durability: Up to 1,000,000 cycles

### Electrical:

Voltage rating: 100Vrms/150Vdc  
 Current rating: 2A (continuous), 3A (peak) per contact  
 Contact resistance: 20m $\Omega$  max.  
 Insulation resistance: 10,000M $\Omega$  min.  
 Dielectric strength: 700Vrms min.  
 Capacitance: 1pF max.

RoHS-2  
2011/65/EU



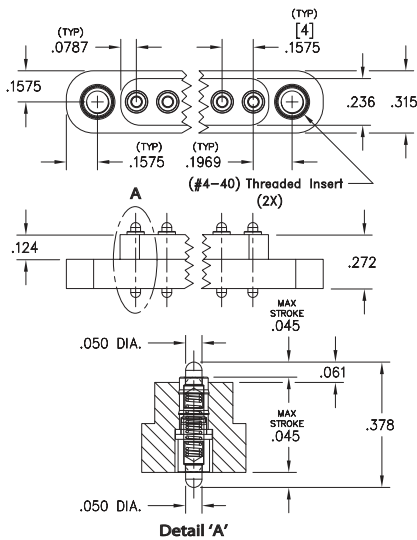


# SPRING-LOADED CONNECTORS

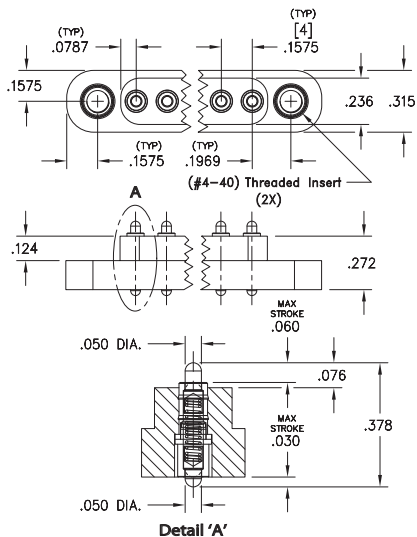
## SERIES 858 • 4MM GRID RUGGED DUAL PLUNGER SOLDERLESS CONNECTOR



### Series 858-22-00X-80-0X1101



### Series 858-22-00X-80-0X2101



- Rugged Modular contacts for use on 4mm grid, supplied in 2 - 6 position connectors
- Precision-machined piston / base and gold-plated components assure up to 1,000,000 cycle life durability (Rated @ Mid-Stroke)
- Low resistance, high current contacts are rated at 9 amps @ 10°C Temperature rise
- Designed for solderless, compression connections between PCB's and/or devices
- Mounting tabs on the housing provide a means for secure attachment to the PCB and may be specified with or without threaded inserts
- Series 858-22-00X-80-0X1101 connectors are designed with dual action plungers. Each plunger is capable of achieving a .045" max. travel individually or simultaneously. Maximum combined stroke of both plungers is .090" per spring pin
- Series 858-22-00X-80-0X2101 connectors are designed with dual action plungers. One plunger is capable of achieving a .030" max. travel and the other is capable of achieving a .060" max. travel. Plungers can achieve their max. travel individually or simultaneously. Maximum combined stroke of both plungers is .090" per spring pin
- See Catalog page 19.74 for assemblies with Alignment pegs

## ORDERING INFORMATION

### Series 858 (.045" travel each Plunger)

858-22-00X-80-0X1101  
 Specify number of pins 2-6      ↑      ↑      No Threaded inserts = 0  
 (#4-40) Threaded inserts = 1

### Series 858 (.030" & .060" travel Plungers)

858-22-00X-80-0X2101  
 Specify number of pins 2-6      ↑      ↑      No Threaded inserts = 0  
 (#4-40) Threaded inserts = 1

## Technical Specifications

### Materials:

Contact piston & base: Machined copper alloy plated 20μ" gold over 100μ" nickel  
 Spring: Stainless Steel 302  
 Insulator: High temperature thermoplastic, rated UL94 V-0

### Mechanical:

Spring force @ initial height: 35 grams  
 Spring force @ mid stroke: 120 grams  
 Durability: Up to 1,000,000 cycles (Rated @ Mid-Stroke)

### Electrical:

Current rating: 9A @ 10° C Temp. rise above ambient (20°C)  
 Contact resistance: 20mΩ max. (Rated @ Mid-Stroke)  
 Insulation resistance: 10,000MΩ min.

RoHS-2  
 2011/65/EU



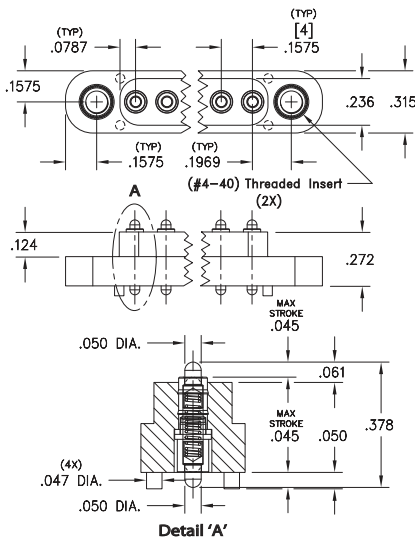
# SPRING-LOADED CONNECTORS

## SERIES 858 • 4MM GRID RUGGED DUAL PLUNGER SOLDERLESS CONNECTOR WITH ALIGNMENT PEGS

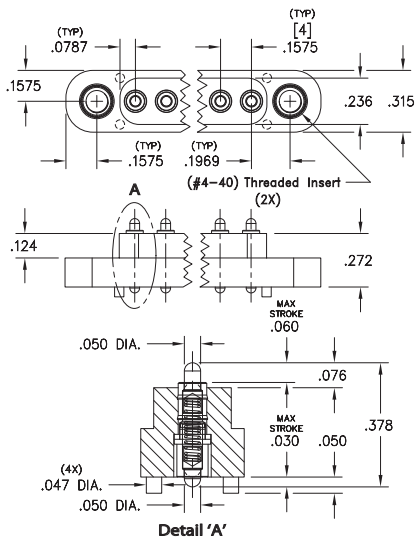


- Rugged Modular contacts for use on 4mm grid, supplied in 2 - 6 position connectors
- Precision-machined piston / base and gold-plated components assure up to 1,000,000 cycle life durability (Rated @ Mid-Stroke)
- Low resistance, high current contacts are rated at 9 amps @ 10°C Temperature rise
- Designed for solderless, compression connections between PCB's and/or devices
- Mounting tabs on the housing provide a means for secure attachment to the PCB and may be specified with or without threaded inserts
- The housing has alignment pegs included to aid in positioning of connector during assembly
- Series 858-22-00X-80-6X1101 connectors are designed with dual action plungers. Each plunger is capable of achieving a .045" max. travel individually or simultaneously. Maximum combined stroke of both plungers is .090" per spring pin
- Series 858-22-00X-80-6X2101 connectors are designed with dual action plungers. One plunger is capable of achieving a .030" max. travel and the other is capable of achieving a .060" max. travel. Plungers can achieve their max. travel individually or simultaneously. Maximum combined stroke of both plungers is .090" per spring pin
- See Catalog page 19.73 for assemblies without Alignment pegs

### Series 858-22-00X-80-6X1101



### Series 858-22-00X-80-6X2101



## ORDERING INFORMATION

### Series 858 (.045" travel each Plunger)

858-22-00X-80-6X1101  
 Specify number of pins 2-6 → → No Threaded inserts = 0  
 (#4-40) Threaded inserts = 1

### Series 858 (.030" & .060" travel Plungers)

858-22-00X-80-6X2101  
 Specify number of pins 2-6 → → No Threaded inserts = 0  
 (#4-40) Threaded inserts = 1

## Technical Specifications

### Materials:

Contact piston & base: Machined copper alloy plated 20μ" gold over 100μ" nickel  
 Spring: Stainless Steel 302  
 Insulator: High temperature thermoplastic, rated UL94 V-0

### Mechanical:

Spring force @ initial height: 35 grams  
 Spring force @ mid stroke: 120 grams  
 Durability: Up to 1,000,000 cycles (Rated @ Mid-Stroke)

### Electrical:

Current rating: 9A @ 10° C Temp. rise above ambient (20°C)  
 Contact resistance: 20mΩ max. (Rated @ Mid-Stroke)  
 Insulation resistance: 10,000MΩ min.

RoHS-2  
 2011/65/EU





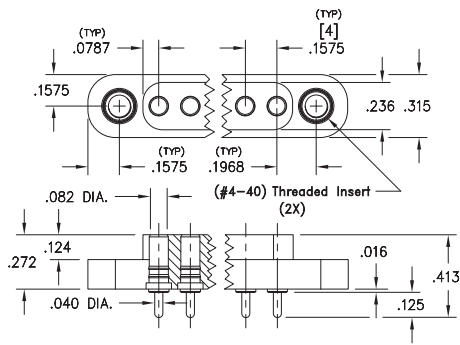
# SPRING-LOADED CONNECTORS

## SERIES 858 • 4MM GRID RUGGED FLAT FACE TARGET CONNECTOR • SURFACE MOUNT AND THROUGH HOLE MOUNT

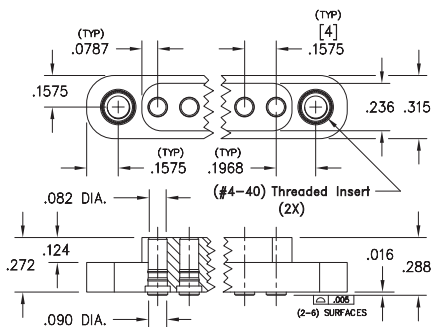


- Rugged Target Connectors for use on 4mm grid, supplied in 2 - 6 position connectors
- Target Connectors provide an excellent gold-plated conductive mating surface for spring-loaded connectors. These series are offered with a flat face for making contact with our 858-22-00X-X0-XX1101 series spring-loaded connectors
- Target connectors use MM #1959-0 and #1969-0 pins. See page 223.5 for details
- Mounting tabs provide a means for secure attachment to the PCB and may be specified with or without threaded inserts
- High temp. thermoplastic insulators are suitable for wave and reflow soldering processes
- Series 858-10-00X-10-0X1000 connectors are designed for manual placement into  $.052" \pm .003"$   $\varnothing$  plated through-holes in the circuit board prior to soldering
- Series 858-10-00X-30-0X1000 and 858-10-00X-30-6X1000 connectors are designed for manual placement onto  $.100"$   $\varnothing$  minimum solder pads

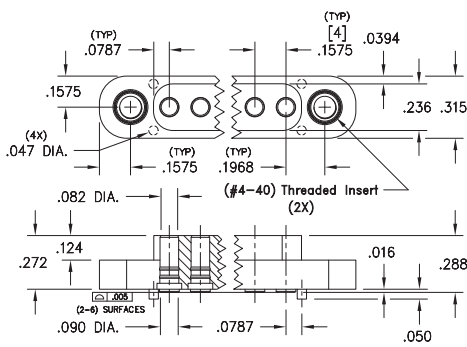
### Series 858-10-00X-10-0X1000



### Series 858-10-00X-30-0X1000



### Series 858-10-00X-30-6X1000



## ORDERING INFORMATION

### Series 858 (Through-Hole Mount)

858-10-00X-10-0X1000  
 Specify number of pins 2-6 → No Threaded inserts = 0  
 (#4-40) Threaded inserts = 1

### Series 858 (Surface Mount)

858-10-00X-30-0X1000  
 Specify number of pins 2-6 → No Threaded inserts = 0  
 (#4-40) Threaded inserts = 1

### Series 858 (Surface Mount with Alignment Pins)

858-10-00X-30-6X1000  
 Specify number of pins 2-6 → No Threaded inserts = 0  
 (#4-40) Threaded inserts = 1

RoHS-2  
2011/65/EU

XX=Plating Code  
See Below

For  
Electrical, Mechanical  
& Environmental Data,  
See page 264

SPECIFY PLATING CODE XX=	10 ◆			
Pin Plating 	10 μ" Au			



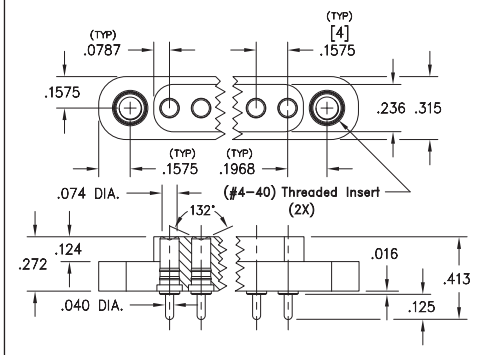
# SPRING-LOADED CONNECTORS

## SERIES 858 • 4MM GRID RUGGED CONCAVE FACE TARGET CONNECTOR • SURFACE MOUNT AND THROUGH HOLE MOUNT

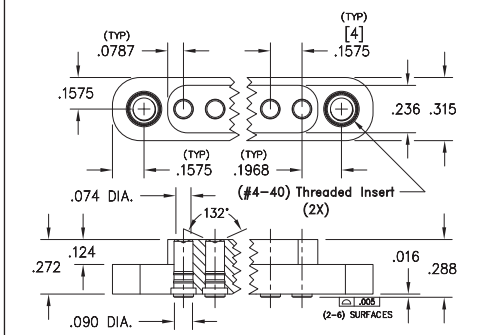


- Rugged Target Connectors for use on 4mm grid, supplied in 2 - 6 position connectors
- Target Connectors provide an excellent gold-plated conductive mating surface for spring-loaded connectors. These series are offered with a concave face providing additional surface area for mating with our 858-22-00X-X0-XX1101 series spring-loaded connectors
- Target connectors use MM #1959-1 and #1969-1 pins. See page 223.5 for details
- Mounting tabs provide a means for secure attachment to the PCB and may be specified with or without threaded inserts
- High temp. thermoplastic insulators are suitable for wave and reflow soldering processes
- Series 858-10-00X-10-0X2000 connectors are designed for manual placement into .052"±.003" Ø plated through-holes in the circuit board prior to soldering
- Series 858-10-00X-30-0X2000 and 858-10-00X-30-6X2000 connectors are designed for manual placement onto .100" Ø minimum solder pads

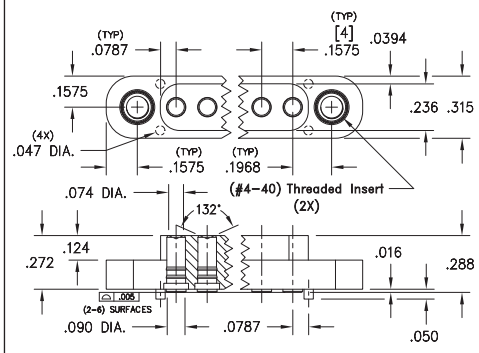
### Series 858-10-00X-10-0X2000



### Series 858-10-00X-30-0X2000



### Series 858-10-00X-30-6X2000



## ORDERING INFORMATION

### Series 858 (Through-Hole Mount)

858-10-00X-10-0X2000

Specify number of pins 2-6 → No Threaded inserts = 0  
 (#4-40) Threaded inserts = 1

### Series 858 (Surface Mount)

858-10-00X-30-0X2000

Specify number of pins 2-6 → No Threaded inserts = 0  
 (#4-40) Threaded inserts = 1

### Series 858 (Surface Mount with Alignment Pins)

858-10-00X-30-6X2000

Specify number of pins 2-6 → No Threaded inserts = 0  
 (#4-40) Threaded inserts = 1



XX=Plating Code  
See Below

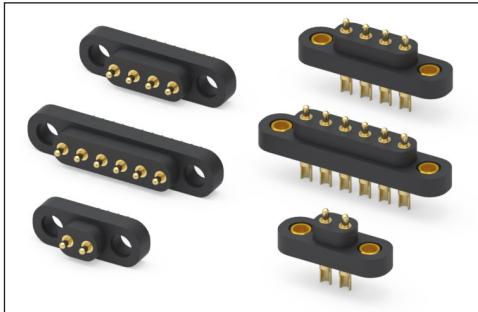
For  
Electrical, Mechanical  
& Environmental Data,  
See page 264

SPECIFY PLATING CODE XX=	10		
Pin Plating 	10 μ" Au		



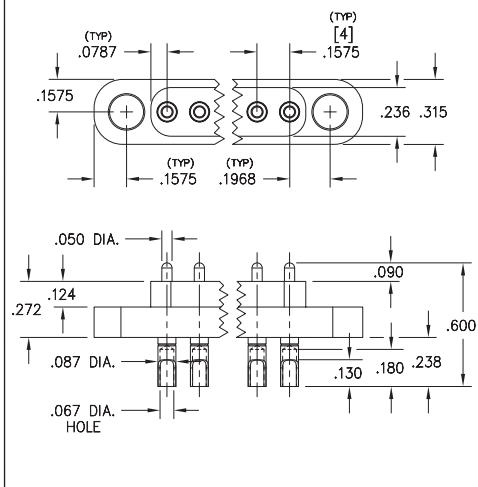
# SPRING-LOADED CONNECTORS

## SERIES 868 • 4MM GRID RUGGED CONNECTORS • SOLDERCUP TERMINATION

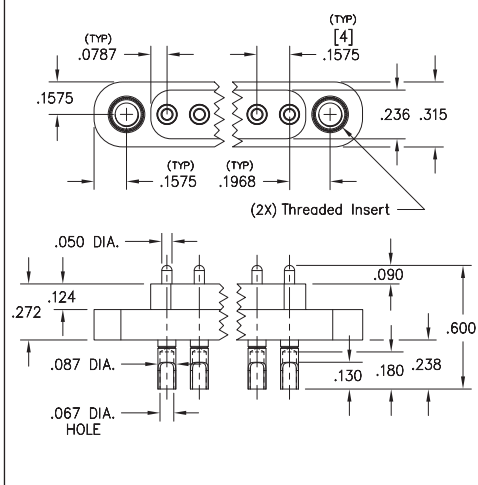


- Rugged Modular contacts for use on 4mm grid, supplied in 2 - 6 position connectors
- Precision-machined piston / base and gold-plated components assure up to 1,000,000 cycle life durability. Pistons have a .045" mid. stroke and a .090" max. stroke
- Mounting tabs provide a means for secure attachment to PCB's, cable assemblies or other housings and may be specified with or without threaded inserts.
- High temperature thermoplastic insulators are suitable for most automated and manual soldering processes
- Series 868-22-00X-00-0X101 connectors are ideal for use with Mill-Max 858 and 868 series SMT, through hole or wire termination target connectors
- Solder cup termination accommodates up to 16 AWG wire
- Series 868-22-00X-00-0X101 use 0868-0 spring-loaded pins. See page 23.1 for details

### Series 868-22-00X-00-001101



### Series 868-22-00X-00-011101



## ORDERING INFORMATION

### Series 868 (Soldercup Termination)

868-22-00X-00-001101  
Specify number of pins 2-6 → No Threaded inserts

### Series 868 (Soldercup Termination)

868-22-00X-00-011101  
Specify number of pins 2-6 → (#4-40) Threaded inserts

## Technical Specifications

### Materials:

Contact piston & base: Machined copper alloy plated 20μ" gold over 100μ" nickel  
Spring: Stainless Steel 302 plated 10μ" gold over nickel  
Insulator: High temperature thermoplastic, rated UL94 V-0

### Mechanical:

Spring force @ initial height: 35 grams  
Spring force @ mid stroke: 120 grams  
Durability: Up to 1,000,000 cycles

### Electrical:

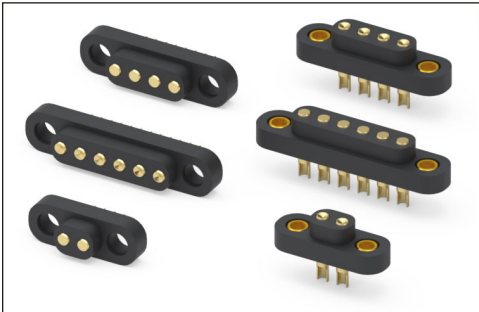
Current rating: 9A @ 10° C Temp. rise above ambient (20°C)  
Contact resistance: 20mΩ max.  
Insulation resistance: 10,000MΩ min.

RoHS - 2  
2011/65/EU



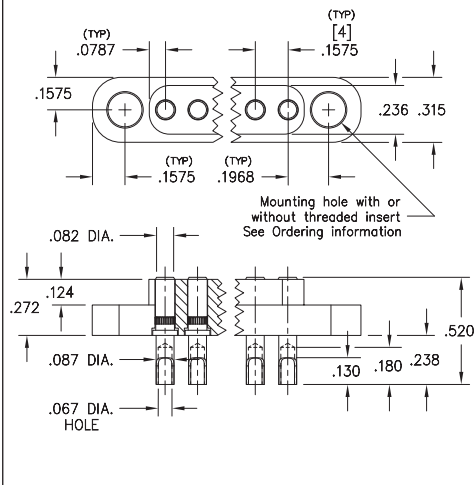
# SPRING-LOADED CONNECTORS

## SERIES 868 • 4MM GRID RUGGED TARGET CONNECTORS FLAT & CONCAVE FACE • SOLDERCUP TERMINATION

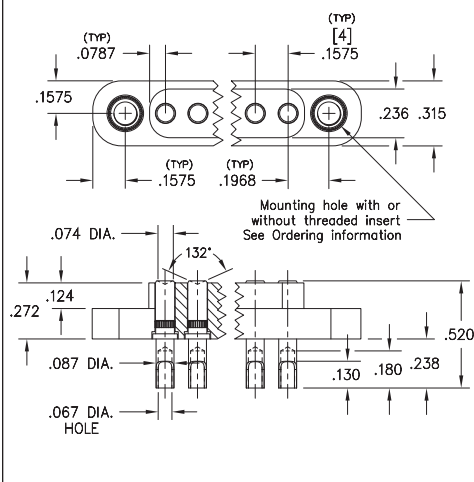


- Rugged Target Connectors for use on 4mm grid, supplied in 2 - 6 position connectors
- Target Connectors provide an excellent gold-plated conductive mating surface for spring-loaded connectors. These series are offered with flat or concave face, providing additional surface area, for mating with Mill-Max 858 and 868 series SMT, through hole or wire termination spring loaded connectors
- Mounting tabs provide a means for secure attachment to PCB's, cable assemblies or other housings and may be specified with or without threaded inserts.
- High temperature thermoplastic insulators are suitable for most automated and manual soldering processes
- Solder cup termination accommodates up to 16 AWG wire
- Series 868-10-00X-00-0X100 use MM #1968-0 target pins & Series 868-10-00X-00-0X200 use #1968-1 target pins. See page 223.5 for details

### Series 868-10-00X-00-0X1000



### Series 868-10-00X-00-0X2000



## ORDERING INFORMATION

### Series 868 (Flat Face Soldercup Termination)

868-10-00X-00-0X1000

Specify number of pins 2-6

No Threaded inserts = 0  
(#4-40) Threaded inserts = 1

### Series 868 (Concave Face Soldercup Termination)

868-10-00X-00-0X2000

Specify number of pins 2-6

No Threaded inserts = 0  
(#4-40) Threaded inserts = 1

RoHS-2  
2011/65/EU

XX=Plating Code  
See Below

For  
Electrical, Mechanical  
& Environmental Data,  
See page 264

SPECIFY PLATING CODE XX=	10			
Pin Plating 	10 μ" Au			



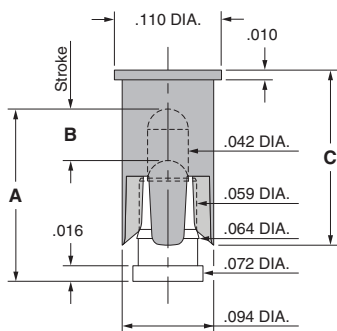
# SPRING-LOADED CONNECTORS

## SERIES 806 • REMOVABLE PICK & PLACE CAP, SPRING-LOADED PINS • SURFACE MOUNT

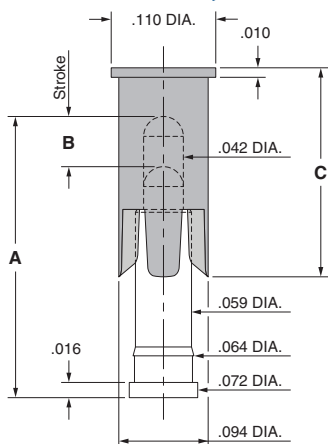


- Surface mount spring-loaded pins with removable pick & place cap are available in nine heights from .137" to .295" with a rated travel of either .0195" or .0275"
- Spring pins used in this series are Mill-Max 0900-X and 0907-X (see page 23 for more details)
- The pick & place cap allows individual spring-loaded contacts to be packaged on tape and reel for automated assembly. The caps are easily removed after soldering leaving only the spring pin on the board.
- Pick & place cap material is high temperature thermoplastic suitable for most SMT soldering processes
- Supplied on 16 mm wide carrier tape, 13" reels; packaging per EIA-481. See below for ordering information

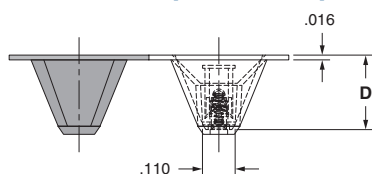
### Series 806 (Contact Style 1,2,3,4,10,11)



### Series 806 (Contact Style 12,13 & 14)



### Series 806 (Tape Pocket Depth)



## ORDERING INFORMATION

### Series 806 (Tape & Reel Packaged)

806-22-001-30-0XX191

Specify contact style 1-4  
Specify contact style 10-14

Contact Style	Initial Height (A)	Rated Travel	Full Stroke Range (B)	Sleeve Height (C)	Tape Depth (D)	Quantity per Reel
1	.137	.0195	.030-.039	.180	.252	780
2	.155	.0195	.030-.039	.180	.252	780
3	.177	.0275	.050-.055	.180	.252	780
4	.197	.0275	.050-.055	.180	.252	780
10	.217	.0275	.050-.055	.220	.285	750
11	.236	.0275	.050-.055	.220	.285	750
12	.255	.0275	.050-.055	.220	.361	550
13	.275	.0275	.050-.055	.220	.361	550
14	.295	.0275	.050-.055	.220	.361	550

### Technical Specifications

#### Materials:

Contact piston & base: Machined copper alloy plated 20 $\mu$ " gold over 100 $\mu$ " nickel  
Spring (Contact style 1-14): Beryllium copper-plated 10 $\mu$ " gold  
Insulator: High temperature thermoplastic, rated UL94 V-0

#### Mechanical:

Spring force @ initial height (A) (Contact style 1-14): 25 grams  
Spring force @ mid stroke (B/2) (Contact style 1-14): 60 grams  
Durability: Up to 1,000,000 cycles

#### Electrical:

Current rating: 2A (continuous), 3A (peak) per contact  
Contact resistance: 20m $\Omega$  max.  
Insulation resistance: 10,000M $\Omega$  min.

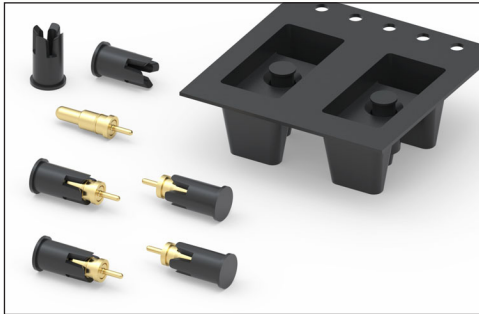
RoHS-2  
2011/65/EU





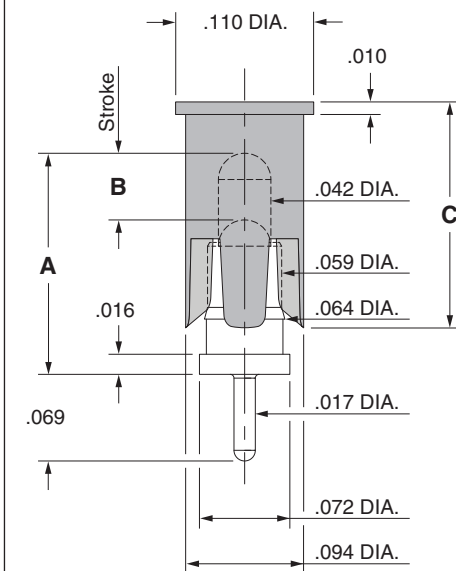
# SPRING-LOADED CONNECTORS

## SERIES 806 • REMOVABLE PICK & PLACE CAP, SPRING-LOADED PINS • THROUGH-HOLE MOUNT

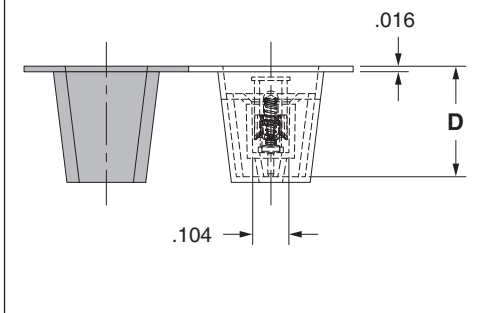


- Through hole mount spring-loaded pins with removable pick & place cap are available in four heights from .137" to .197" with a rated travel of either .0195" or .0275"
- Spring pins used in this series are Mill-Max 0906-X (see page 25 for more details)
- The pick & place cap allows individual spring-loaded contacts to be packaged on tape and reel for automated assembly. The caps are easily removed after soldering leaving only the spring pin on the board
- Pick & place cap material is high temperature thermoplastic suitable for most SMT soldering processes
- Supplied on 24 mm wide carrier tape, 13" reels; packaging per EIA-481. See below for ordering information

Series 806 (Contact Style 1-4)



Series 806 (Tape Pocket Depth)



### ORDERING INFORMATION

#### Series 806 (Tape & Reel Packaged)

806-22-001-10-00X191

Specify contact style 1-4

Contact Style	Initial Height (A)	Rated Travel	Full Stroke Range (B)	Sleeve Height (C)	Tape Depth (D)	Quantity per Reel
1	.137	.0195	.030-.039	.180	.317	640
2	.155	.0195	.030-.039	.180	.317	640
3	.177	.0275	.050-.055	.180	.317	640
4	.197	.0275	.050-.055	.180	.317	640

#### Technical Specifications

##### Materials:

Contact piston & base: Machined copper alloy plated 20μ" gold over 100μ" nickel

Spring (Contact style 1-4): Beryllium copper-plated 10μ" gold

Insulator: High temperature thermoplastic, rated UL94 V-0

##### Mechanical:

Spring force @ initial height (A) (Contact style 1-4): 25 grams

Spring force @ mid stroke (B/2) (Contact style 1-4): 60 grams

Durability: Up to 1,000,000 cycles

##### Electrical:

Current rating: 2A (continuous), 3A (peak) per contact

Contact resistance: 20mΩ max.

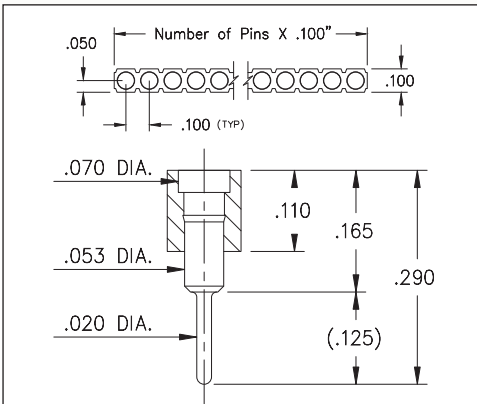
Insulation resistance: 10,000MΩ min.

RoHS-2  
2011/65/EU

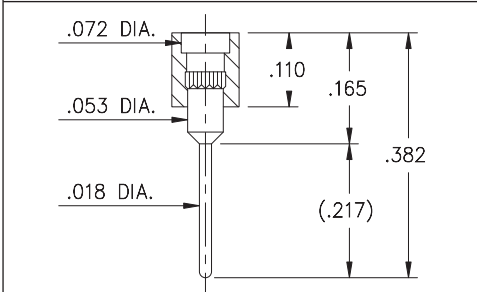


# SPRING-LOADED CONNECTORS

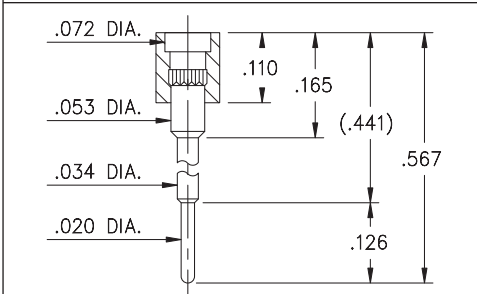
## SERIES 319, 330 • .100" GRID TARGET CONNECTORS FOR SPRING-LOADED ASSEMBLIES • SINGLE ROW STRIPS



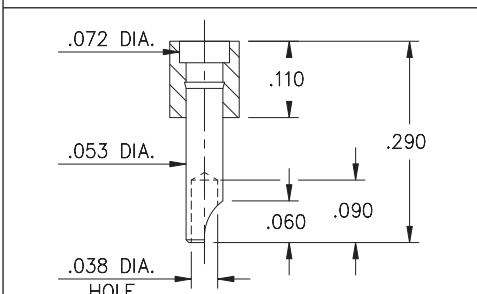
**FIG. 1**



**FIG. 2**

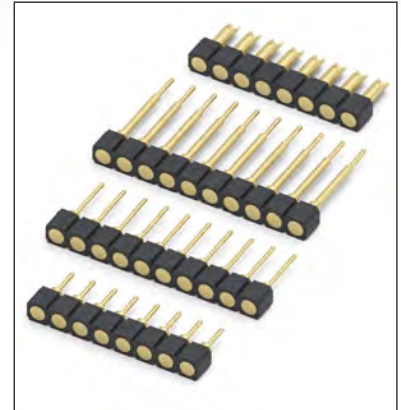


**FIG. 3**



**FIG. 4**

- Series 319 and 330 Spring Target Connectors, supplied in single row strips. Available in through-hole and wire termination configurations
- Target Connectors provide an excellent gold-plated conductive mating surface for spring loaded connectors. These series are offered with a flat face for making contact with our standard .042" dia. spring pin plungers
- Target connectors use MM #1938, #1940, #1942 and #3024 pins. See page 218 for details
- Insulators are high temperature thermoplastic



### ORDERING INFORMATION

	Series 319...001	Standard Solder Tails
<b>FIG. 1</b>	319-10-1	-00-001000 Specify number of pins 01-64
<b>FIG. 2</b>	Series 319...002	Long Solder Tails
	319-10-1	-00-002000 Specify number of pins 01-64
<b>FIG. 3</b>	Series 319...005	Elevated with Solder Tails
	319-10-1	-00-005000 Specify number of pins 01-64
<b>FIG. 4</b>	Series 330...240	Solder Cups
	330-10-1	-00-240000 Specify number of pins 01-64



XX=Plating Code See Below

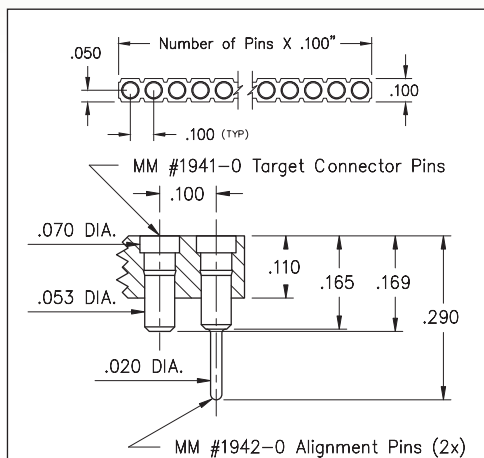
For Electrical, Mechanical & Environmental Data, See page 264

SPECIFY PLATING CODE XX=	10			
Pin Plating	 10 μ" Au			

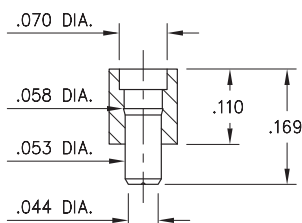


# SPRING-LOADED CONNECTORS

## SERIES 319, 399 • .100" GRID TARGET CONNECTORS FOR SPRING-LOADED ASSEMBLIES • SINGLE ROW STRIPS

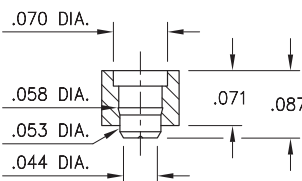


**FIG. 1**



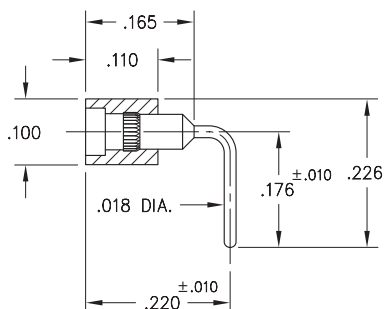
Coplanarity .005". For Pin counts >10 positions, consult Technical Support.

**FIG. 2**



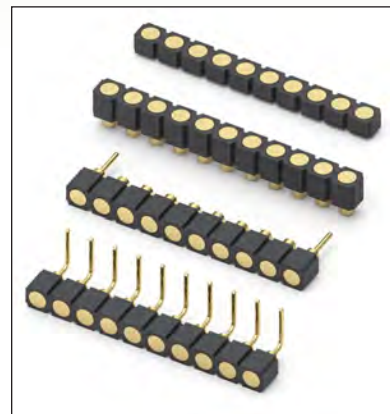
Coplanarity .005". For Pin counts >10 positions, consult Technical Support.

**FIG. 3**



**FIG. 4**

- Series 319 and 399 Spring Target Connectors, supplied in single row strips. Available in SMT and right angle through-hole termination configurations
- Target Connectors provide an excellent gold-plated conductive mating surface for spring loaded connectors. These series are offered with a flat face for making contact with our standard .042" dia. spring pin plungers
- Target connectors use MM #1940, #1941/1942, #1953 and #1954 pins. See pages 218 & 223.3 for details
- Insulators are high temperature thermoplastic



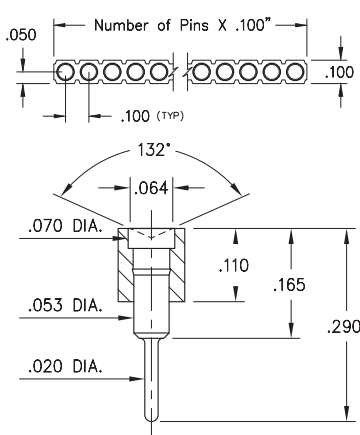
### ORDERING INFORMATION

	Series 319...041	Surface Mount w/ Alignments Pins
<b>FIG. 1</b>	319-10-1	-30-041000 Specify number of pins 03-64
<b>FIG. 2</b>	Series 319...008	Surface Mount 319-10-1 -30-008000 Specify number of pins 01-64
<b>FIG. 3</b>	Series 319...054	Low Profile Surface Mount 319-10-1 -30-054000 Specify number of pins 01-64
<b>FIG. 4</b>	Series 399...008	Right Angle Solder Tails 399-10-1 -10-008000 Specify number of pins 01-64
<div style="display: flex; justify-content: space-around; align-items: center;"> <div style="border: 1px solid black; padding: 5px; background-color: #90EE90;">RoHS-2 2011/65/EU</div> <div style="border: 1px solid black; border-radius: 50%; padding: 5px;">XX=Plating Code See Below</div> <div style="border: 1px solid black; border-radius: 50%; padding: 5px;">For Electrical, Mechanical &amp; Environmental Data, See page 264</div> </div>		
SPECIFY PLATING CODE XX=		
Pin Plating	10  10 μ" Au	

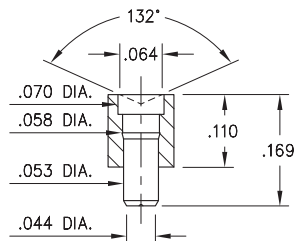


# SPRING-LOADED CONNECTORS

## SERIES 319, 399 • .100" GRID CONCAVE FACE TARGET CONNECTORS FOR SPRING-LOADED ASSEMBLIES • SINGLE ROW STRIPS

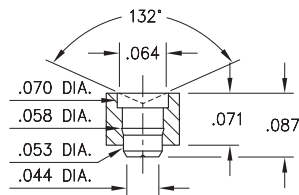


**FIG. 1**



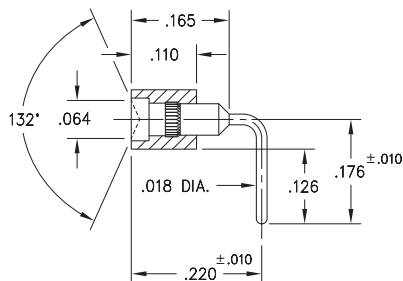
Coplanarity .005". For Pin counts >10 positions, consult Technical Support.

**FIG. 2**



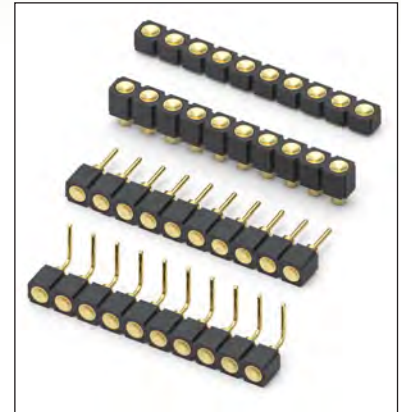
Coplanarity .005". For Pin counts >10 positions, consult Technical Support.

**FIG. 3**



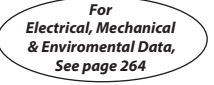


**FIG. 4**

- Series 319 and 399 Spring Target Connectors, supplied in single row strips. Available in SMT and right angle through-hole termination configurations
- Target Connectors provide an excellent gold-plated conductive mating surface for spring loaded connectors. These series are offered with a concave face for making contact with our standard .042" dia. spring pin plungers
- Target connectors use MM #1948, #1955, #1957 and #1960 pins. See pages 223.1, 223.2 and 223.3 for details
- Insulators are high temperature thermoplastic



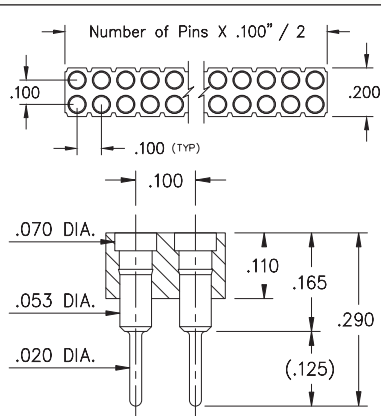
### ORDERING INFORMATION

	Series 319...006	Standard Solder Tails
<b>FIG. 1</b>	319-10-1	-00-006000
	Specify number of pins	01-64
	Series 319...007	Surface Mount
<b>FIG. 2</b>	319-10-1	-30-007000
	Specify number of pins	01-64
	Series 319...055	Low Profile Surface Mount
<b>FIG. 3</b>	319-10-1	-30-055000
	Specify number of pins	01-64
	Series 399...007	Right Angle Solder Tails
<b>FIG. 4</b>	399-10-1	-10-007000
	Specify number of pins	01-64
  		
<b>SPECIFY PLATING CODE XX=</b>	10	
Pin Plating	10 μ" Au	

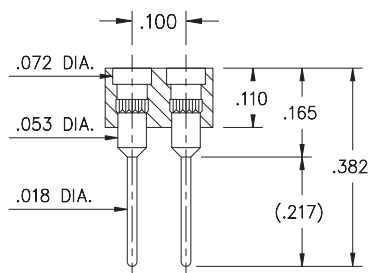


# SPRING-LOADED CONNECTORS

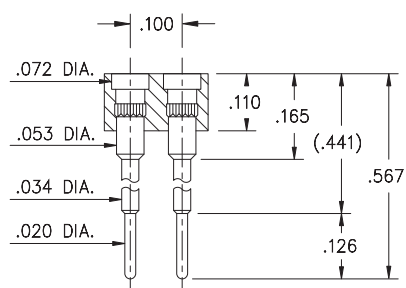
## SERIES 419, 430 • .100" GRID TARGET CONNECTORS FOR SPRING-LOADED ASSEMBLIES • DOUBLE ROW STRIPS



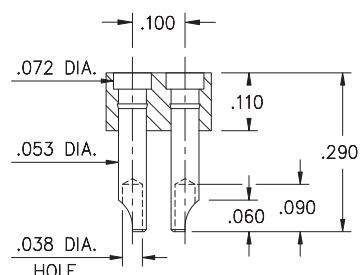
**FIG. 1**



**FIG. 2**

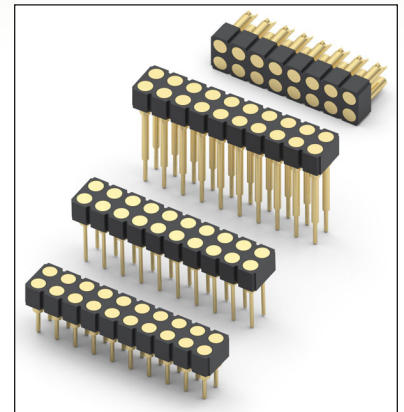


**FIG. 3**



**FIG. 4**

- Series 419 and 430 Spring Target Connectors, supplied in double row strips. Available in through-hole and wire termination configurations
- Target Connectors provide an excellent gold-plated conductive mating surface for spring loaded connectors. These series are offered with a flat face for making contact with our standard .042" dia. spring pin plungers
- Target connectors use MM #1938, #1940, #1942 and #3024 pins. See page 218 for details
- Insulators are high temperature thermoplastic

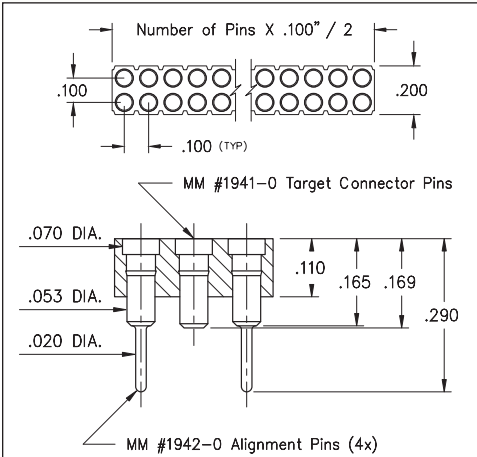


### ORDERING INFORMATION

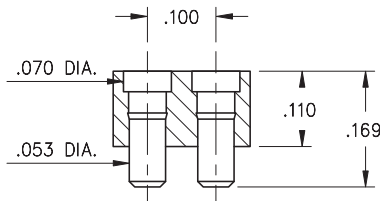
	Series 419...001	Standard Solder Tails
<b>FIG. 1</b>	419-10-2	-00-001000 Specify number of pins 04-64
<b>FIG. 2</b>	Series 419...002	Long Solder Tails
	419-10-2	-00-002000 Specify number of pins 04-64
<b>FIG. 3</b>	Series 419...005	Elevated with Solder Tails
	419-10-2	-00-005000 Specify number of pins 04-64
<b>FIG. 4</b>	Series 430...240	Solder Cups
	430-10-2	-00-240000 Specify number of pins 04-64
<div style="display: flex; justify-content: space-around; align-items: center;"> <div style="border: 1px solid green; padding: 5px; color: white;">RoHS-2 2011/65/EU</div> <div style="border: 1px solid black; border-radius: 50%; padding: 5px;">XX=Plating Code See Below</div> <div style="border: 1px solid black; border-radius: 50%; padding: 5px;">For Electrical, Mechanical &amp; Environmental Data, See page 264</div> </div>		
SPECIFY PLATING CODE XX=		
Pin Plating	10 <span style="color: green;">◆</span>	10 μ" Au

# SPRING-LOADED CONNECTORS

## SERIES 419, 499 • .100" GRID TARGET CONNECTORS FOR SPRING-LOADED ASSEMBLIES • DOUBLE ROW STRIPS

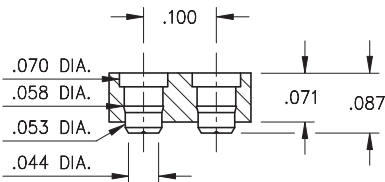


**FIG. 1**



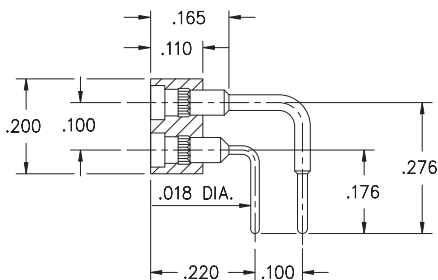
Coplanarity .005". For Pin counts >20 positions, consult Technical Support.

**FIG. 2**



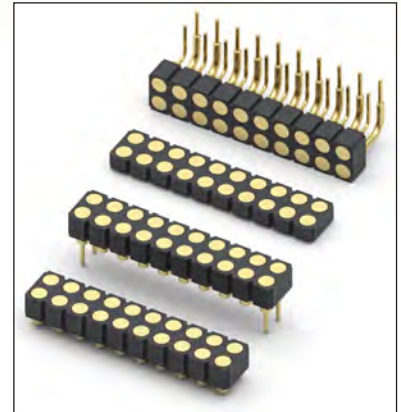
Coplanarity .005". For Pin counts >20 positions, consult Technical Support.

**FIG. 3**



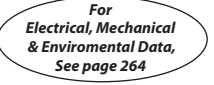




**FIG. 4**

- Series 419 and 499 Spring Target Connectors, supplied in double row strips. Available in SMT and right angle through-hole termination configurations
- Target Connectors provide an excellent gold-plated conductive mating surface for spring loaded connectors. These series are offered with a flat face for making contact with our standard .042" dia. spring pin plungers
- Target connectors use MM #1940, #1941/1942, #1953 and #1954 pins. See pages 218 & 223.3 for details
- Insulators are high temperature thermoplastic



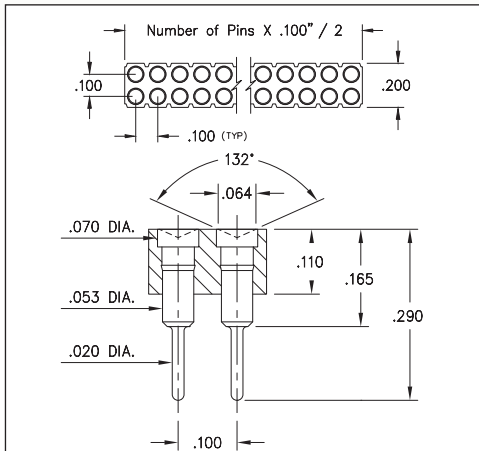
### ORDERING INFORMATION

<b>FIG. 1</b>	<b>Series 419...042</b> <b>Surface Mount w/ Alignments Pins</b>
	419-10-2__-30-042000 Specify number of pins      06-72
<b>FIG. 2</b>	<b>Series 419...041</b> <b>Surface Mount</b>
	419-10-2__-30-041000 Specify number of pins      04-72
<b>FIG. 3</b>	<b>Series 419...054</b> <b>Low Profile Surface Mount</b>
	419-10-2__-30-054000 Specify number of pins      04-72
<b>FIG. 4</b>	<b>Series 499...008</b> <b>Right Angle Solder Tails</b>
	499-10-2__-10-008000 Specify number of pins      02-64
  	
<b>SPECIFY PLATING CODE XX=</b>	10 
Pin Plating 	10 μ" Au

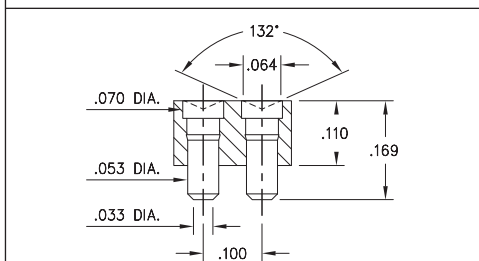


# SPRING-LOADED CONNECTORS

## SERIES 419, 499 • .100" GRID CONCAVE FACE TARGET CONNECTORS FOR SPRING-LOADED ASSEMBLIES • DOUBLE ROW STRIPS

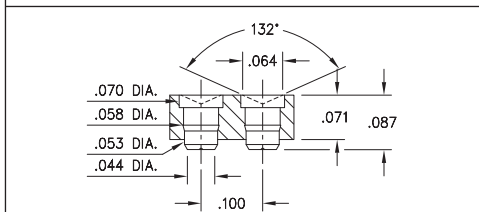


**FIG. 1**



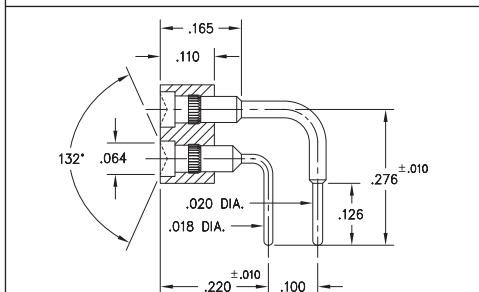
Coplanarity .005". For Pin counts >20 positions, consult Technical Support.

**FIG. 2**



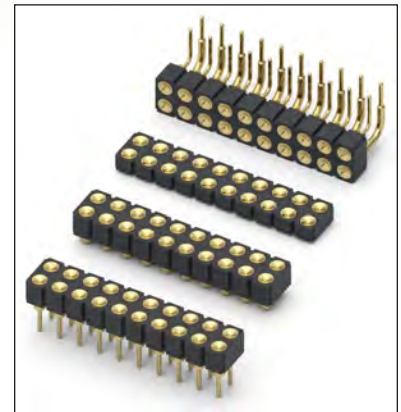
Coplanarity .005". For Pin counts >20 positions, consult Technical Support.

**FIG. 3**



**FIG. 4**

- Series 419 and 499 Spring Target Connectors, supplied in double row strips. Available in SMT and right angle through-hole termination configurations
- Target Connectors provide an excellent gold-plated conductive mating surface for spring loaded connectors. These series are offered with a concave face for making contact with our standard .042" dia. spring pin plungers
- Target connectors use MM #1947, #1948, #1955 and #1958/1960 pins. See pages 223.1, 223.2 and 223.3 for details
- Insulators are high temperature thermoplastic



### ORDERING INFORMATION

	Series 419...006	Standard Solder Tails
<b>FIG. 1</b>	419-10-2	-00-006000
	Specify number of pins	04-64
<b>FIG. 2</b>	419-10-2	-30-007000
	Specify number of pins	04-72
<b>FIG. 3</b>	419-10-2	-30-055000
	Specify number of pins	04-72
<b>FIG. 4</b>	499-10-2	-10-007000
	Specify number of pins	02-64



XX=Plating Code  
See Below

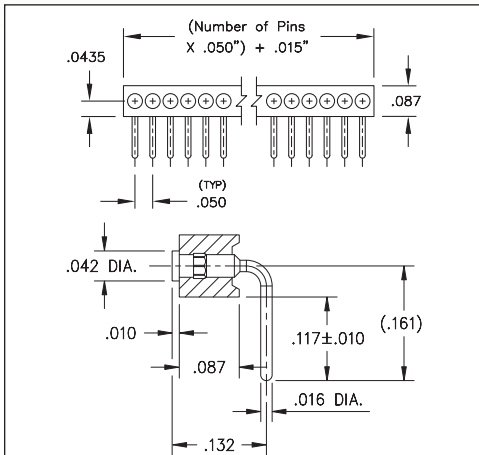
For  
Electrical, Mechanical  
& Environmental Data,  
See page 264

SPECIFY PLATING CODE XX=	10			
Pin Plating 	10 μ" Au			

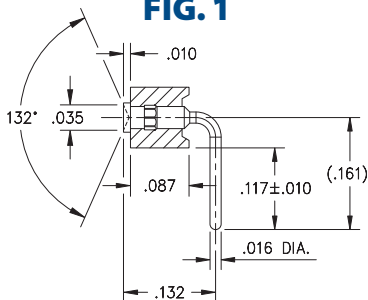


# SPRING-LOADED CONNECTORS

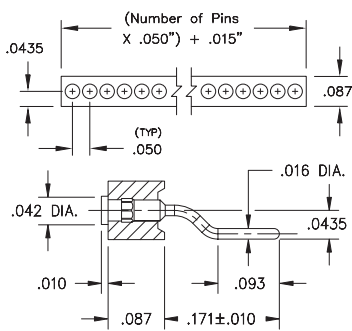
## SERIES 856 • .050" GRID FLAT & CONCAVE FACE TARGET CONNECTORS FOR SPRING-LOADED ASSEMBLIES • SINGLE ROW STRIPS



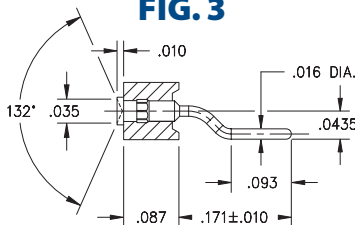
**FIG. 1**



**FIG. 2**



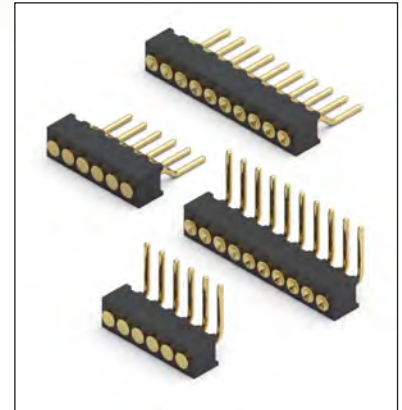
**FIG. 3**





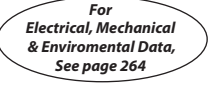

**FIG. 4**

Coplanarity .005". For Pin counts >20 positions, consult Technical Support.

- Series 856 Spring Target Connectors, supplied in single row strips
- Spring Target Connectors are offered with a flat or concave surface for making contact with our standard .019" dia. spring pin plungers. The target connectors provide an excellent gold-plated conductive path back to the board-mounted spring pin connector
- Target connectors use MM #1831-1 and #1931-1 pins. See page 223.2 for details
- Insulators are high temperature thermoplastic



### ORDERING INFORMATION

	Series 856...20-001	Flat face / Right Angle
<b>FIG. 1</b>	856-10-0	-20-001000
	Specify number of pins	01-20
	Series 856...20-002	Concave face / Right Angle
<b>FIG. 2</b>	856-10-0	-20-002000
	Specify number of pins	01-20
	Series 856...40-001	Flat face / Surface Mount
<b>FIG. 3</b>	856-10-0	-40-001000
	Specify number of pins	01-20
	Series 856...40-002	Concave face / Surface Mount
<b>FIG. 4</b>	856-10-0	-40-002000
	Specify number of pins	01-20
  		
<b>SPECIFY PLATING CODE XX=</b>		
Pin Plating	10 	10 μ" Au





# SPRING-LOADED CONNECTORS

## SERIES 856, 857 • .050" GRID CONCAVE FACE TARGET CONNECTORS FOR SPRING-LOADED ASSEMBLIES • SINGLE AND DOUBLE ROW STRIPS

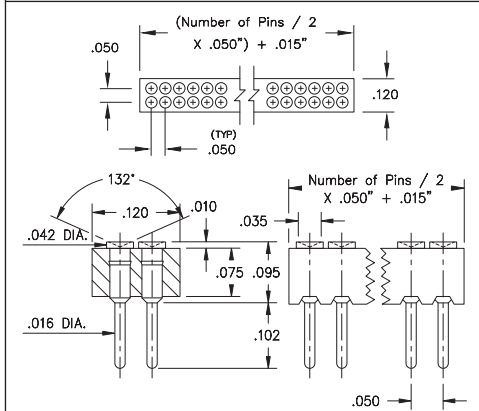


**FIG. 1**

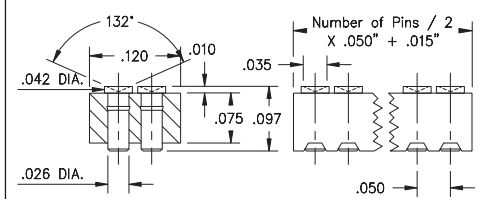


Coplanarity .005". For Pin counts >20 positions, consult Technical Support.

**FIG. 2**



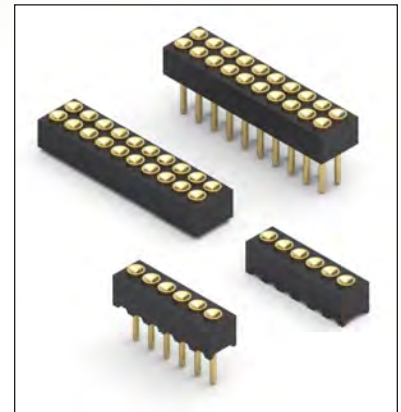
**FIG. 3**



Coplanarity .005". For Pin counts >40 positions, consult Technical Support.

**FIG. 4**

- Series 856 and 857 Target Connectors, SMT & through-hole, supplied in single and double row strips
- Target Connectors provide an excellent gold-plated conductive mating surface for spring loaded connectors. These series are offered with a concave face for making contact with our standard .019" dia. spring pin plungers
- Target connectors use MM #1934 (through-hole) and #1936 (surface mount) pins. See page 223.2 for details
- Insulators are high temperature thermoplastic



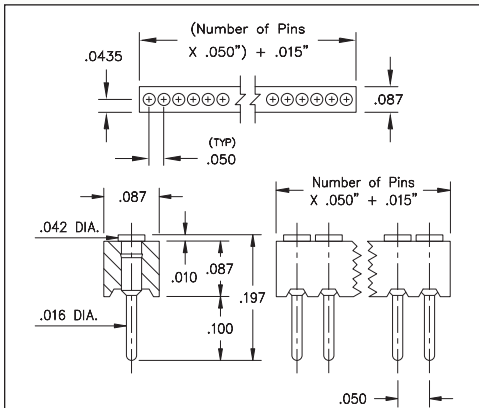
### ORDERING INFORMATION

	Series 856...10-002	Concave face / Solder Tails										
<b>FIG. 1</b>	856-10-0	-10-002000 Specify number of pins 01-20										
<b>FIG. 2</b>	Series 856...30-002	Concave face / Surface Mount 856-10-0 -30-002000 Specify number of pins 02-20										
<b>FIG. 3</b>	Series 857...10-002	Concave face / Solder Tails 857-10-0 -10-002000 Specify number of pins 04-40										
<b>FIG. 4</b>	Series 857...30-002	Concave face / Surface Mount 857-10-0 -30-002000 Specify number of pins 04-40										
<div style="display: flex; justify-content: space-around; align-items: center;"> <div style="border: 1px solid black; padding: 5px; background-color: #90EE90;">RoHS-2 2011/65/EU</div> <div style="border: 1px solid black; border-radius: 50%; padding: 5px;">XX=Plating Code See Below</div> <div style="border: 1px solid black; border-radius: 50%; padding: 5px;">For Electrical, Mechanical &amp; Environmental Data, See page 264</div> </div>												
<table border="1" style="width: 100%; border-collapse: collapse;"> <thead> <tr> <th style="width: 30%;">SPECIFY PLATING CODE XX=</th> <th style="width: 10%;">10</th> <th style="width: 10%;"></th> <th style="width: 10%;"></th> <th style="width: 10%;"></th> </tr> </thead> <tbody> <tr> <td>Pin Plating </td> <td>10 μ" Au</td> <td></td> <td></td> <td></td> </tr> </tbody> </table>			SPECIFY PLATING CODE XX=	10				Pin Plating	10 μ" Au			
SPECIFY PLATING CODE XX=	10											
Pin Plating	10 μ" Au											

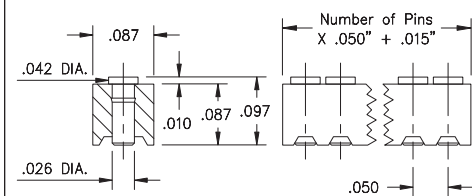


# SPRING-LOADED CONNECTORS

## SERIES 856, 857 • .050" GRID TARGET CONNECTORS FOR SPRING-LOADED ASSEMBLIES • SINGLE AND DOUBLE ROW STRIPS

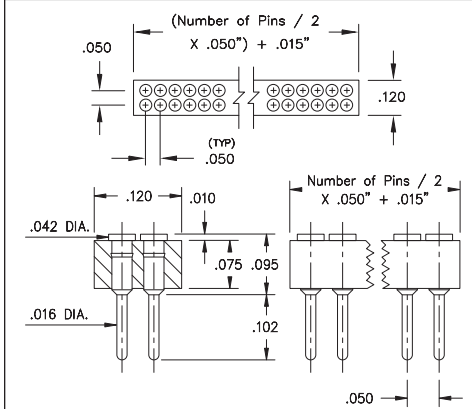


**FIG. 1**

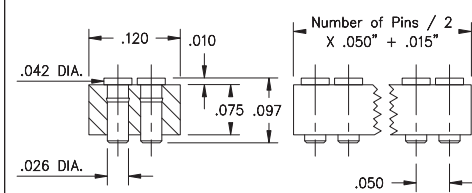


Coplanarity .005". For Pin counts >20 positions, consult Technical Support.

**FIG. 2**



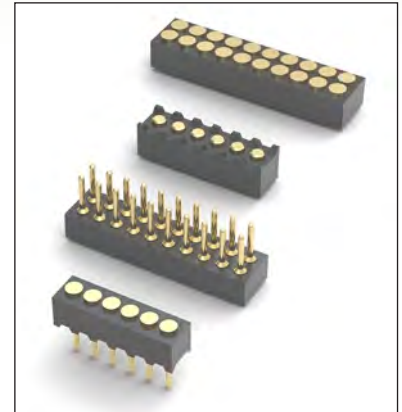
**FIG. 3**



Coplanarity .005". For Pin counts >40 positions, consult Technical Support.

**FIG. 4**

- Series 856 and 857 Target Connectors, SMT & through-hole, supplied in single and double row strips
- Target Connectors provide an excellent gold-plated conductive mating surface for spring loaded connectors. These series are offered with a flat face for making contact with our standard .019" dia. spring pin plungers
- Target connectors use MM #1933 (through-hole) and #1935 (surface mount) pins. See page 223.2 for details
- Insulators are high temperature thermoplastic



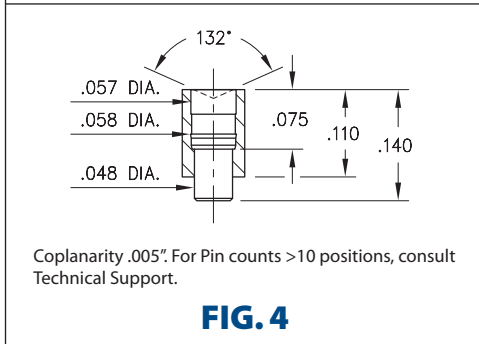
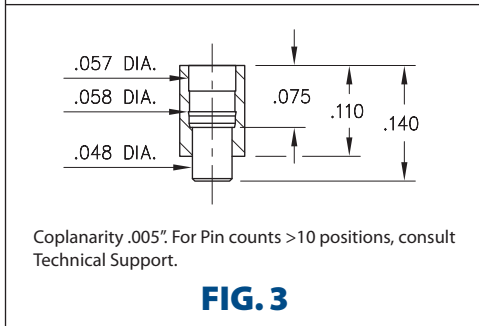
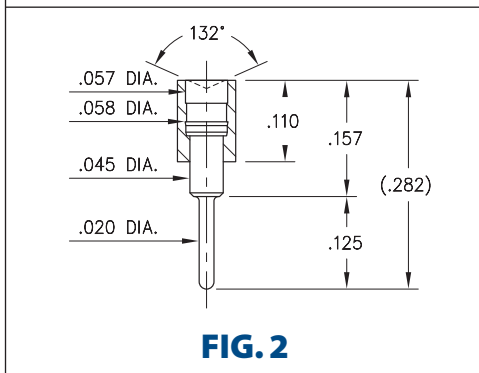
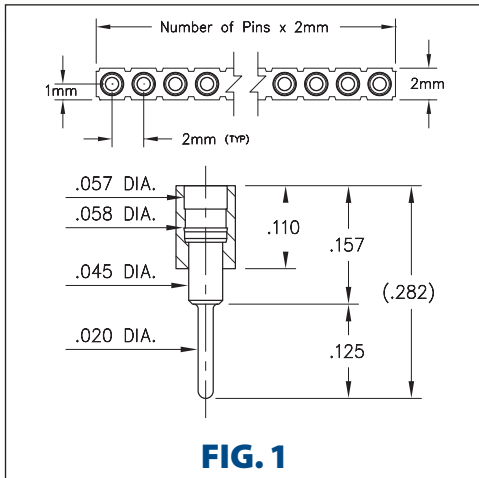
### ORDERING INFORMATION

	Series 856...051	Flat face / Solder Tails
<b>FIG. 1</b>	856-10-0	-10-051000 Specify number of pins 01-20
<b>FIG. 2</b>	Series 856...051	Flat face / Surface Mount
<b>FIG. 2</b>	856-10-0	-30-051000 Specify number of pins 02-20
<b>FIG. 3</b>	Series 857...051	Flat face / Solder Tails
<b>FIG. 3</b>	857-10-0	-10-051000 Specify number of pins 04-40
<b>FIG. 4</b>	Series 857...051	Flat face / Surface Mount
<b>FIG. 4</b>	857-10-0	-30-051000 Specify number of pins 04-40
<div style="display: flex; justify-content: space-around; align-items: center;"> <div style="border: 1px solid black; padding: 5px; background-color: #90EE90;">RoHS-2 2011/65/EU</div> <div style="border: 1px solid black; border-radius: 50%; padding: 5px;">XX=Plating Code See Below</div> <div style="border: 1px solid black; border-radius: 50%; padding: 5px;">For Electrical, Mechanical &amp; Environmental Data, See page 264</div> </div>		
SPECIFY PLATING CODE XX=		
Pin Plating	10  10 μ" Au	

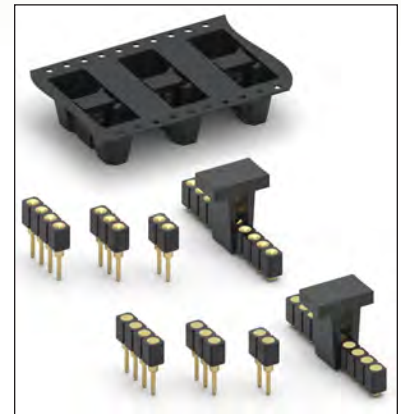


# SPRING-LOADED CONNECTORS



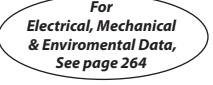


## SERIES 830 • 2mm GRID FLAT & CONCAVE FACE TARGET CONNECTORS FOR SPRING-LOADED ASSEMBLIES • SINGLE ROW STRIPS



- Series 830 2mm Spring Target Connectors, supplied in single row strips
- Target connectors provide an excellent gold-plated conductive path back to the board-mounted spring pin connector. Available in both through-hole and SMT terminations with the choice of either flat or concave face contact surfaces. Concave face targets provide additional surface area for mating with our standard .032" diameter plungers
- Target connectors use MM #1949, #1950, #1951, and #1952 pins. See page 223.1 for details
- Insulators are high temperature thermoplastic

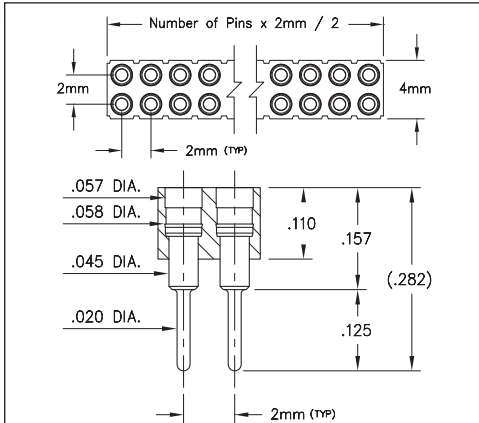


### ORDERING INFORMATION

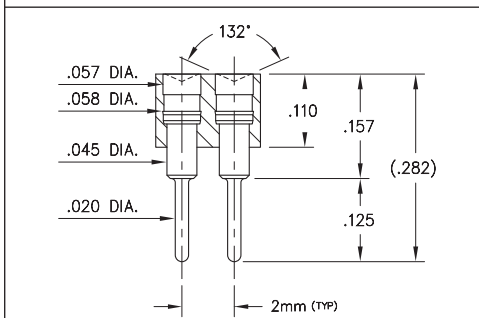
<b>FIG. 1</b>	<b>Series 830...003</b> <b>Flat face / Solder Tails</b>
	830-10-0__-10-003000 Specify number of pins    01-20
<b>FIG. 2</b>	<b>Series 830...004</b> <b>Concave face / Solder Tails</b>
	830-10-0__-10-004000 Specify number of pins    01-20
<b>FIG. 3</b>	<b>Series 830...30-003</b> <b>Flat face / Surface Mount</b>
	830-10-0__-30-003XXX Specify number or pins    02-10 Tube packaged = 000 Tape & reel packaged = 191 400 parts per 13" reel
<b>FIG. 4</b>	<b>Series 830...30-004</b> <b>Concave face / Surface Mount</b>
	830-10-0__-30-004XXX Specify number or pins    02-10 Tube packaged = 000 Tape & reel packaged = 191 400 parts per 13" reel
  	
<b>SPECIFY PLATING CODE XX=</b>	10 
Pin Plating 	10 μ" Au

# SPRING-LOADED CONNECTORS

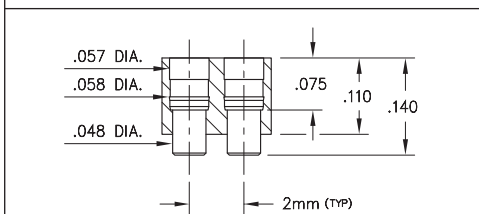
## SERIES 832 • 2mm GRID FLAT & CONCAVE FACE TARGET CONNECTORS FOR SPRING-LOADED ASSEMBLIES • DOUBLE ROW STRIPS



**FIG. 1**

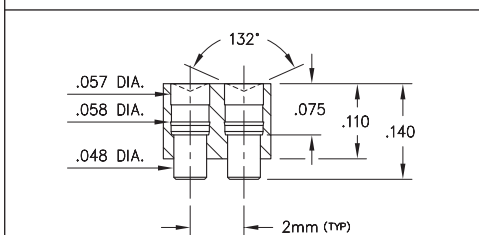


**FIG. 2**



Coplanarity .005". For Pin counts >20 positions, consult Technical Support.

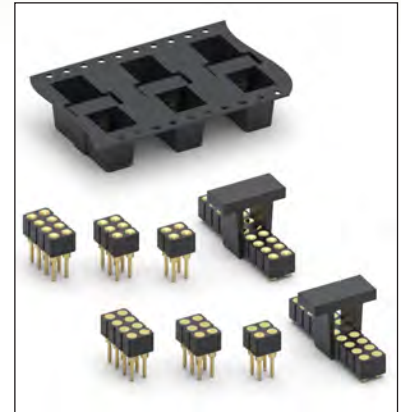
**FIG. 3**



Coplanarity .005". For Pin counts >20 positions, consult Technical Support.

**FIG. 4**

- Series 832 2mm Spring Target Connectors, supplied in double row strips
- Target connectors provide an excellent gold-plated conductive path back to the board-mounted spring pin connector. Available in both through-hole and SMT terminations with the choice of either flat or concave face contact surfaces. Concave face targets provide additional surface area for mating with our standard .032" diameter plungers
- Target connectors use MM #1949, #1950, #1951, and #1952 pins. See page 223.1 for details
- Insulators are high temperature thermoplastic

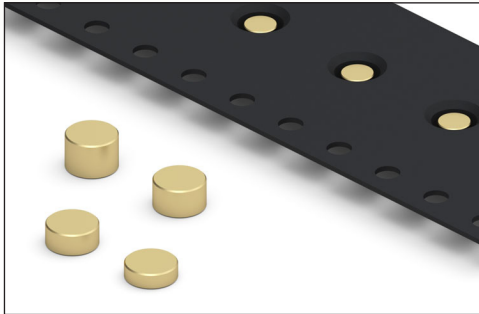


### ORDERING INFORMATION

<b>FIG. 1</b>	<b>Series 832...003</b> <b>Flat face / Solder Tails</b>
	832-10-0__-10-003000 Specify number of pins ↑ 04-20
<b>FIG. 2</b>	<b>Series 832...004</b> <b>Concave face / Solder Tails</b>
	832-10-0__-10-004000 Specify number of pins ↑ 04-20
<b>FIG. 3</b>	<b>Series 832...30-003</b> <b>Flat face / Surface Mount</b>
	832-10-0__-30-003XXX Specify number or pins ↑ 04-20 Tube packaged = 000 Tape & reel packaged = 191 400 parts per 13" reel
<b>FIG. 4</b>	<b>Series 832...30-004</b> <b>Concave face / Surface Mount</b>
	832-10-0__-30-004XXX Specify number or pins ↑ 04-20 Tube packaged = 000 Tape & reel packaged = 191 400 parts per 13" reel
<div style="display: flex; justify-content: space-around; align-items: center;"> <div style="border: 1px solid black; padding: 5px; background-color: #90EE90;">RoHS-2 2011/65/EU</div> <div style="border: 1px solid black; border-radius: 50%; padding: 5px;">XX=Plating Code See Below</div> <div style="border: 1px solid black; border-radius: 50%; padding: 5px;">For Electrical, Mechanical &amp; Enviromental Data, See page 264</div> </div>	
<b>SPECIFY PLATING CODE XX=</b>	10 ◆
Pin Plating	10 μ" Au

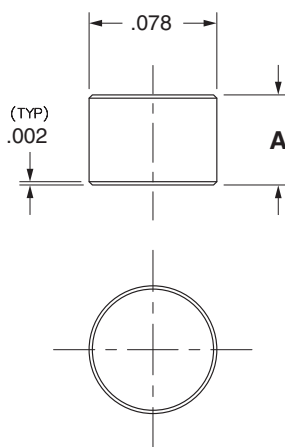
# SPRING-LOADED CONNECTORS

## SERIES 1578 • LOW PROFILE TARGET DISCS • SURFACE MOUNT

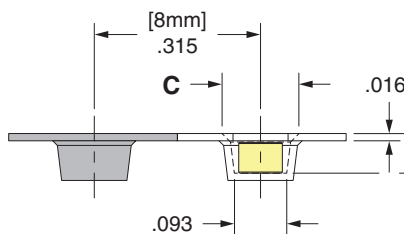


- The 1578-X-57-15-00-00-03-0 Surface mount disc is .078" in diameter and available in four heights from .025" to .055" +/- .002" tall. Employing our precision machining expertise we are able to achieve flat surfaces on both sides of the disc with virtually no burrs. The flat surfaces are ideal for surface mount soldering and as the conductive mating surface for spring loaded pins and connectors as well as test probes. The discs are typically placed on solder pasted PCB pads and then subjected to reflow soldering. Once soldered the terminals are ready to be used as reliable, durable contact points.
- The 1578-X's are packaged on tape & reel - 16 mm wide x 8 mm pitch, making them simple to integrate into existing pick & place equipment and assembly processes. The tape packaging is per EIA-481-D
- Custom sizes are quickly and easily achievable via Mill-Max's high speed precision machining processes. You can contact our technical support team to discuss your particular application and requirements.

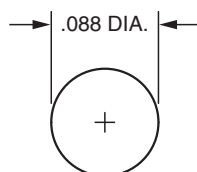
Series 1578 (Target Disc)



Series 1578 (Tape Pocket Details)



Series 1578 (Suggested footprint layout)



### ORDERING INFORMATION

#### Series 1578 (Tape & Reel Packaged)

1578-X-57-15-00-00-03-0

Specify contact style (0-3)

Contact Style	Target Disc Height (A)	Tape Pocket Depth (B)	Tape Pocket Opening (C)	Quantity per Reel
0	.025	.035	.120	7,200
1	.035	.045	.130	6,000
2	.045	.055	.131	5,125
3	.055	.065	.133	4,000

XX=Plating Code  
See Below

For  
Electrical, Mechanical  
& Environmental Data,  
See page 264

SPECIFY PLATING CODE XX=

15

Pin Plating



10 μ" Au

#### SPECIFICATIONS:

**Pin Material:** Brass Alloy 385 or 360, 1/2 Hard

**Dimensions:** Inches

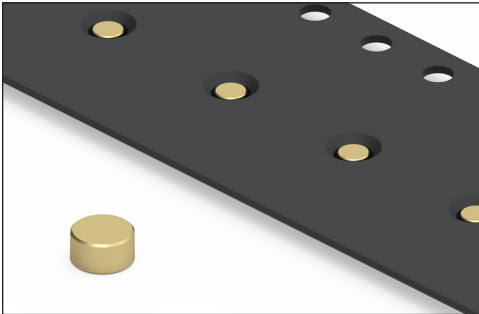
**Tolerances On:** Lengths: ± .002  
Diameters: ± .001  
Angles: ± 2°

RoHS-2  
2011/65/EU



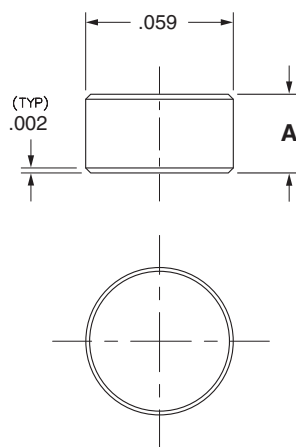
# SPRING-LOADED CONNECTORS

## SERIES 1559 • LOW PROFILE TARGET DISCS • SURFACE MOUNT

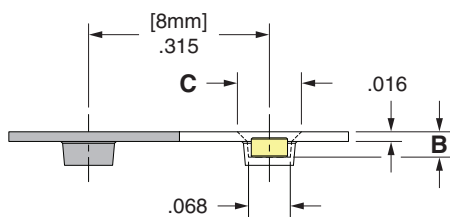


- The 1559-1-57-15-00-00-03-0 Surface mount disc is .059" in diameter. Employing our precision machining expertise we are able to achieve flat surfaces on both sides of the disc with virtually no burrs. The flat surfaces are ideal for surface mount soldering and as the conductive mating surface for spring loaded pins and connectors as well as test probes. The discs are typically placed on solder pasted PCB pads and then subjected to reflow soldering. Once soldered the terminals are ready to be used as reliable, durable contact points.
- The 1559-1 are packaged on tape & reel - 16 mm wide x 8 mm pitch, making them simple to integrate into existing pick & place equipment and assembly processes. The tape packaging is per EIA-481-D
- Custom sizes are quickly and easily achievable via Mill-Max's high speed precision machining processes. You can contact our technical support team to discuss your particular application and requirements.

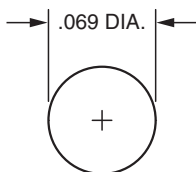
Series 1559 (Target Disc)



Series 1559 (Tape Pocket Details)



Series 1559 (Suggested footprint layout)



### ORDERING INFORMATION

#### Series 1559 (Tape & Reel Packaged)

1559-X-57-15-00-00-03-0

Specify contact style ( 1 )

Contact Style	Target Disc Height (A)	Tape Pocket Depth (B)	Tape Pocket Opening (C)	Quantity per Reel
1	.0315	.041	.104	6,000

XX=Plating Code  
See Below

For  
Electrical, Mechanical  
& Environmental Data,  
See page 264

SPECIFY PLATING CODE XX=	15			
Pin Plating	10 μ" Au			

#### SPECIFICATIONS:

**Pin Material:** Brass Alloy 385 or 360, 1/2 Hard

**Dimensions:** Inches

**Tolerances On:** Lengths: ± .002  
Diameters: ± .001  
Angles: ± 2°

RoHS-2  
2011/65/EU



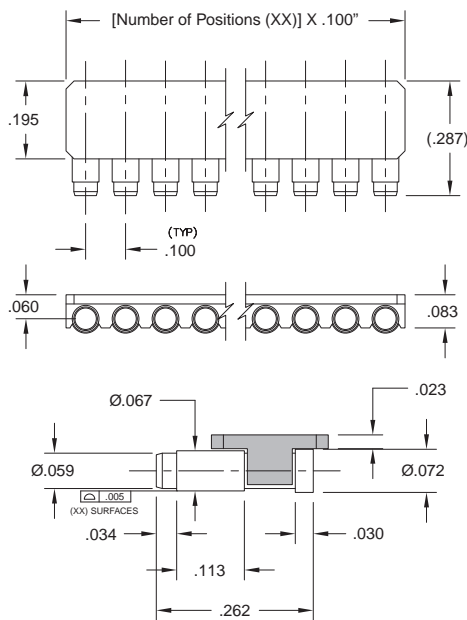
# SPRING-LOADED CONNECTORS

## SERIES 319 • .100" GRID HSMT TARGET CONNECTORS FOR SPRING-LOADED ASSEMBLIES • SINGLE ROW STRIPS

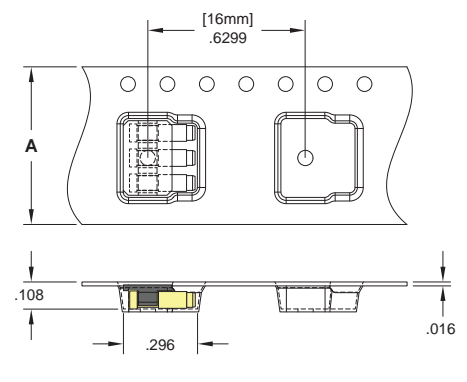


- Series 319 HSMT Spring Target Connectors, supplied in single row strips
- Target Connectors provide an excellent gold-plated conductive mating surface for spring loaded connectors. This series is offered with a flat face for making contact with our standard .042" dia. spring pin plungers
- These target connectors provide a low profile, horizontal surface mount connection to the PCB and are designed to mate with standard .100" pitch spring loaded connectors. They are ideal for daisy chaining P.C.B.'s when mated with SLC 810-22-1XX-40-005191 or for mating boards in a perpendicular orientation
- The 319 series is packaged on tape & reel - 16, 24, 32 or 44 mm wide x 16 mm pitch, making them simple to integrate into existing pick & place equipment and assembly processes. The tape packaging is per EIA-481-D

**Series 319 (HSMT Target)**



**Series 319 (Tape Pocket Details)**



## ORDERING INFORMATION

### Series 319 (Tape & Reel Packaged)

319-10-1\_\_-40-080001  
Specify number of pins      02-10

Number of Pins	Tape Width Size (A)	Quantity per Reel
2	16mm	1,450
3	16mm	1,450
4	24mm	1,450
5	24mm	1,450
6	24mm	1,450
7	32mm	1,450
8	32mm	1,450
9	44mm	1,450
10	44mm	1,450

XX=Plating Code  
See Below

For  
Electrical, Mechanical  
& Environmental Data,  
See page 264

SPECIFY PLATING CODE XX=	10			
Pin Plating	10 μ" Au			

### Technical Specifications

**Materials:**

Pin Material: Brass Alloy 385 or 360, 1/2 Hard  
Pin Finish: 10μ" Gold over Nickel  
Insulator: High temperature Nylon 46, rated UL94 V-0

**Electrical:**

Insulation resistance: 10,000MΩ min.  
Dielectric strength: 700Vrms min.

