

SPRING-LOADED CONNECTORS

SERIES 854 & 855 • 1,27 GRID THROUGH-HOLE MOUNT • SINGLE AND DOUBLE ROW STRIPS

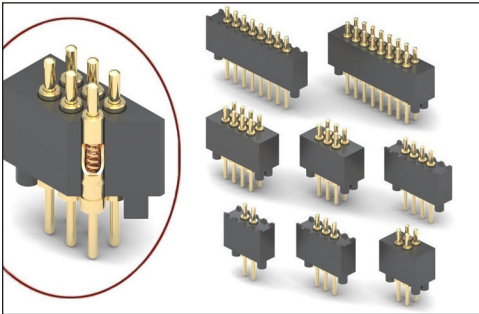

- Modular contacts for use on 1,27 grid, supplied in single and double row contact strips
- Precision-machined piston / base and gold-plated components assure up to 100,000 cycle life durability
- Pistons have a 0,7 mid. stroke and a 1,4 max. stroke
- Low resistance, high current contacts are rated at 2 amps continuous, 3 amps peak
- High temperature thermoplastic insulators are suitable for wave and reflow processes
- Both 854 & 855 series contact strips are designed for manual placement into $\varnothing 0,58 \pm 0,08$ plated through-holes in the circuit board prior to hand, wave or reflow soldering

SINGLE ROW Series 854

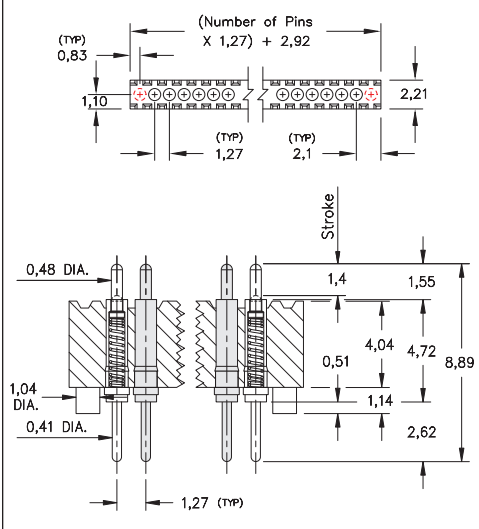

DOUBLE ROW Series 855

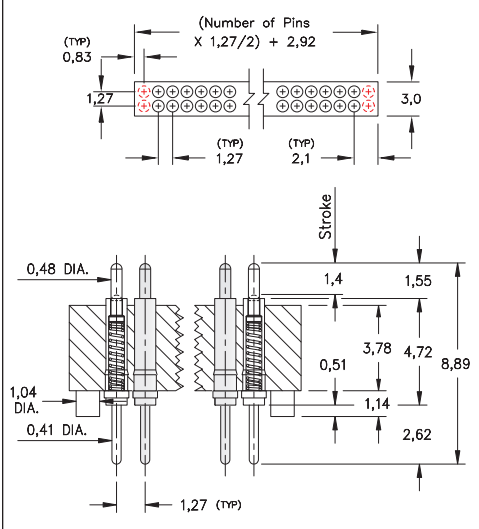

ORDERING INFORMATION

Single Row Series 854

854-22-0XX-10-001101

Specify number of contacts 02-20

Double Row Series 855

855-22-0XX-10-001101

Specify number of contacts 04-40

Technical Specifications

Materials:

Contact piston & base: Machined copper alloy plated 0,51 μm gold over 2,54 μm nickel
 Spring: Beryllium copper-plated 0,25 μm gold
 Insulator: High temperature thermoplastic, rated UL94 V-0

Mechanical:

Spring force @ initial height: 25 grams
 Spring force @ mid stroke (0,7): 60 grams
 Durability: Up to 100,000 cycles

Electrical:

Voltage rating: 100Vrms/150Vdc
 Current rating: 2A (continuous), 3A (peak) per contact
 Contact resistance: 20m Ω max.
 Insulation resistance: 10,000M Ω min.
 Dielectric strength: 700Vrms min.
 Capacitance: 1pF max.

RoHS-2
2011/65/EU

