

MAXIMUM SOLUTIONS

Mill-Max Expands Spring-Loaded Target Connector Lineup With Concave Face Right Angle, HSMT, and More

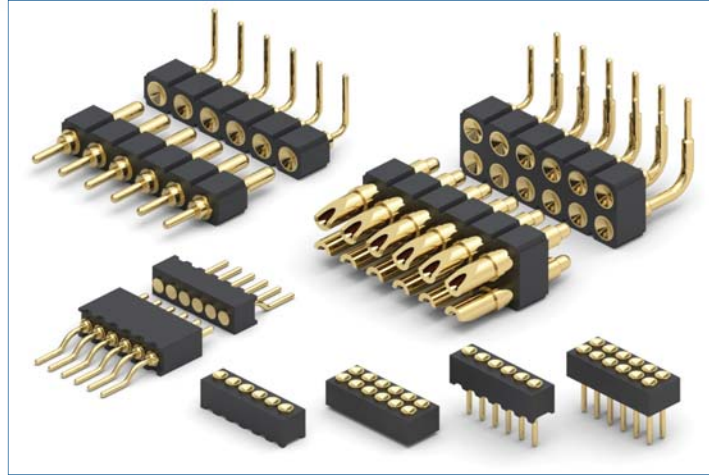

Mill-Max is expanding its selection of target connectors in both our .100" (2,54mm) and .050" (1,27mm) grid families. Target connectors are used in place of SMT pads on a PCB as the mating surface for spring-loaded pins. The new series include right angle with concave mating face (.100" grid), through-hole and surface mount with concave face (.050" grid) and horizontal surface mount and right angle (.050" grid) with both flat and concave face options available.

Combining target connectors with spring-loaded connectors on opposing boards can be a simple and convenient solution for making connections between stacked boards or docking stations and devices.

As a complement to our existing .100" grid right angle target connectors, we are introducing two new series featuring targets with concave faces. The single row series is [399-10-1XX-10-007000](#) and the double row is [499-10-2XX-10-007000](#); both are for through-hole mounting.

In our .050" grid lineup, we have added concave face versions of our SMT and through-hole target connectors: [856-10-0XX-10-002000](#) (single row, through-hole); [856-10-0XX-30-002000](#) (single row, SMT); [857-10-0XX-10-002000](#) (double row, through hole); [857-10-0XX-30-002000](#) (double row, SMT).

Concave face targets provide additional surface area for mating and can aid in centering/alignment of components and/or boards fitted with spring-loaded connectors.

Rounding out the lineup of new target connectors are right angle and horizontal surface mount (HSMT) versions on .050" grid. These connectors provide low profile options for parallel or right angle board mating arrangements. The HSMT version is especially suited for daisy chaining applications such as those found in LED strip lighting assemblies. These connectors will be available with both flat and concave face options. The right angle series are [856-10-0XX-20-001000](#) (flat face) and [856-10-0XX-20-002000](#) (concave face); the HSMT series are [856-10-0XX-40-001000](#) (flat face) and [856-10-0XX-40-002000](#) (concave face).

All the pins are precision-machined and gold-plated for environmental protection, durability and reliable conductivity. The connector insulators are molded from high temperature plastic suitable for most soldering processes, including RoHS environments. All of these products are RoHS compliant. See the attached catalog pages for further details.

For more information, please visit: www.mill-max.com/PR662.

(2/16 -- PR662)

Mill-Max Mfg. Corp. • 190 Pine Hollow Road, Oyster Bay, NY 11771
516-922-6000 • Fax: 516-922-9253 • www.mill-max.com



SPRING-LOADED CONNECTORS

SERIES 319, 399 • .100" GRID CONCAVE FACE TARGET CONNECTORS FOR SPRING-LOADED ASSEMBLIES • SINGLE ROW STRIPS

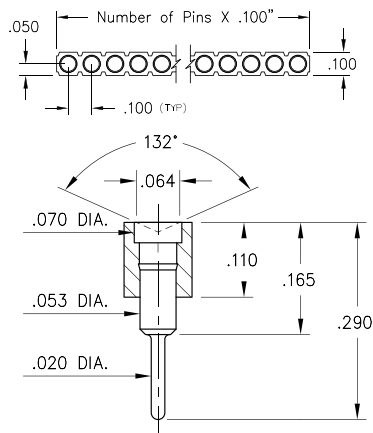

FIG. 1

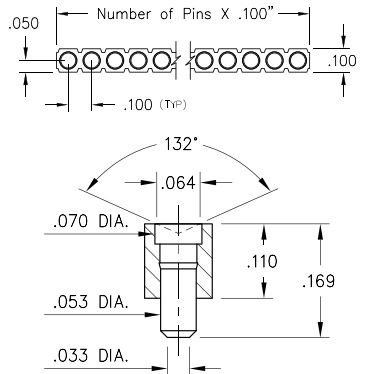

FIG. 2

Coplanarity .005". For Pin counts >20 positions, consult Technical Support.

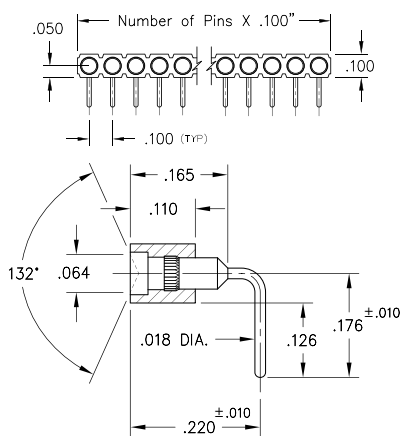
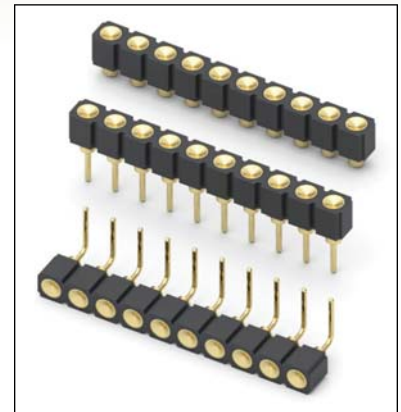

FIG. 3

- Series 319 and 399 Spring Target Connectors, supplied in single row strips
- The concave face provides more surface area for mating with our standard .042" diameter plungers and an improved interface for misaligned connectors. Target connectors provide an excellent gold-plated conductive path back to the board-mounted spring pin connector
- Target connectors use MM #1947, #1948 and #1960 pins. See pages 223.1 & 223.2 for details
- Insulators are high temperature thermoplastic



ORDERING INFORMATION

	Series 319...006	Standard Solder Tails
FIG. 1	319-10-1	-00-006000
	Specify number of pins	01-64
FIG. 2	Series 319...007	Surface Mount
	319-10-1	-00-007000
	Specify number of pins	02-32
FIG. 3	Series 399...007	Right Angle Solder Tails
	399-10-1	-10-007000
	Specify number of pins	01-64
<div style="display: flex; justify-content: space-around; align-items: center;"> <div style="border: 1px solid black; padding: 5px; background-color: #90EE90;">RoHS-2 2011/65/EU</div> <div style="border: 1px solid black; border-radius: 50%; padding: 5px;">XX=Plating Code See Below</div> <div style="border: 1px solid black; border-radius: 50%; padding: 5px;">For Electrical, Mechanical & Environmental Data, See page 264</div> </div>		
SPECIFY PLATING CODE XX=		
Pin Plating	10 ◆	10 μ" Au



SPRING-LOADED CONNECTORS

SERIES 419, 499 • .100" GRID CONCAVE FACE TARGET CONNECTORS FOR SPRING-LOADED ASSEMBLIES • DOUBLE ROW STRIPS

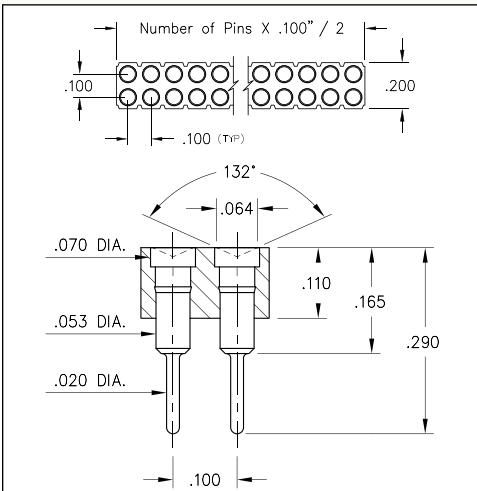
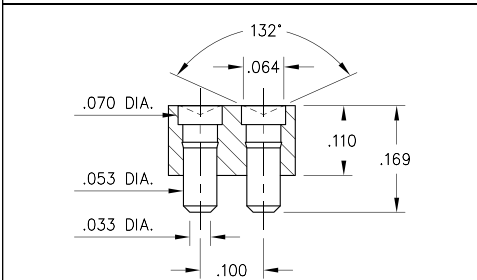

FIG. 1



Coplanarity .005". For Pin counts >20 positions, consult Technical Support.

FIG. 2

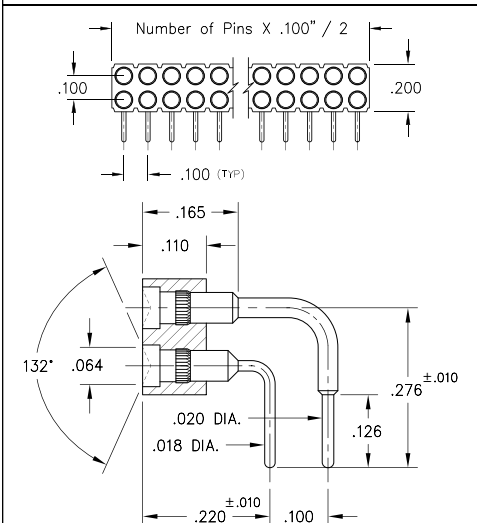
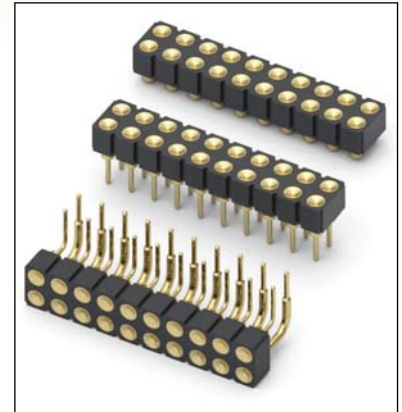

FIG. 3

- Series 419 and 499 Spring Target Connectors, supplied in double row strips
- The concave face provides more surface area for mating with our standard .042" diameter plungers and an improved interface for misaligned connectors. Target connectors provide an excellent gold-plated conductive path back to the board-mounted spring pin connector
- Target connectors use MM #1947, #1948 and #1958/#1960 pins. See pages 223.1 & 223.2 for details
- Insulators are high temperature thermoplastic



ORDERING INFORMATION

	Series 419...006	Standard Solder Tails
FIG. 1	419-10-2	-00-006000
	Specify number of pins	04-64
FIG. 2	Series 419...007	Surface Mount
	419-10-2	-30-007000
	Specify number of pins	04-64
FIG. 3	Series 499...007	Right Angle Solder Tails
	499-10-2	-10-007000
	Specify number of pins	04-64
<div style="display: flex; justify-content: space-around; align-items: center;"> <div style="border: 1px solid black; padding: 5px; background-color: #90EE90;">RoHS-2 2011/65/EU</div> <div style="border: 1px solid black; border-radius: 50%; padding: 5px;">XX=Plating Code See Below</div> <div style="border: 1px solid black; border-radius: 50%; padding: 5px;">For Electrical, Mechanical & Environmental Data, See page 264</div> </div>		
SPECIFY PLATING CODE XX=	10	
Pin Plating	10 μ" Au	



SPRING-LOADED CONNECTORS

SERIES 856 • .050" GRID FLAT & CONCAVE FACE TARGET CONNECTORS FOR SPRING-LOADED ASSEMBLIES • SINGLE ROW STRIPS

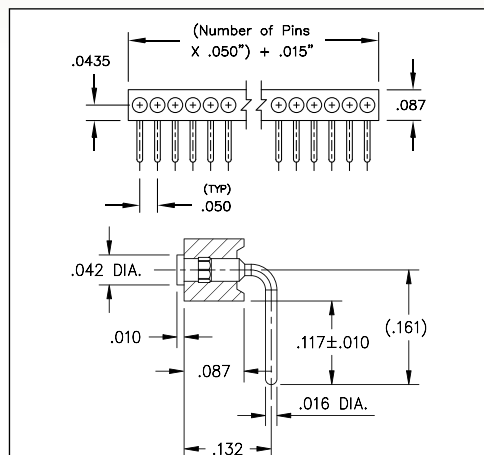

FIG. 1

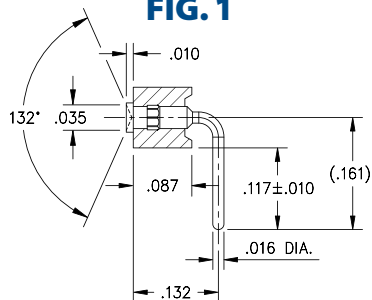

FIG. 2

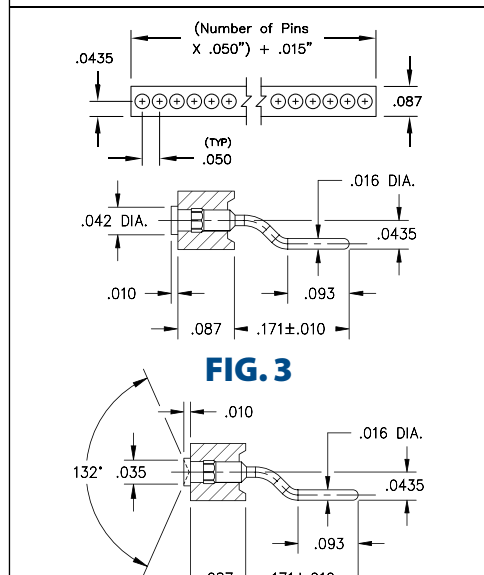

FIG. 3

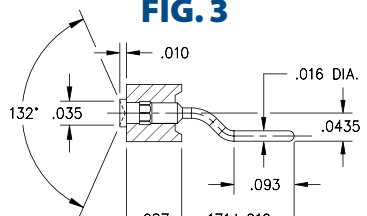
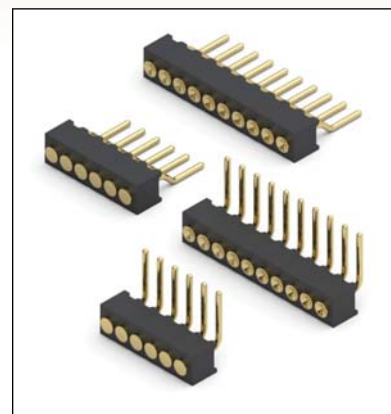

FIG. 4

Coplanarity .005". For Pin counts >20 positions, consult Technical Support.

- Series 856 Spring Target Connectors, supplied in single row strips
- Spring Target Connectors are offered with a flat or concave surface for making contact with our standard .019" dia. spring pin plungers. The target connectors provide an excellent gold-plated conductive path back to the board-mounted spring pin connector
- Target connectors use MM #1831-1 and #1931-1 pins. See page 223.2 for details
- Insulators are high temperature thermoplastic



ORDERING INFORMATION

	Series 856...20-001	Flat face / Right Angle
FIG. 1	856-10-0	-20-001000
	Specify number of pins	01-20
	Series 856...20-002	Concave face / Right Angle
FIG. 2	856-10-0	-20-002000
	Specify number of pins	01-20
	Series 856...40-001	Flat face / Surface Mount
FIG. 3	856-10-0	-40-001000
	Specify number of pins	01-20
	Series 856...40-002	Concave face / Surface Mount
FIG. 4	856-10-0	-40-002000
	Specify number of pins	01-20
<div style="display: flex; justify-content: space-around; align-items: center;"> <div style="border: 1px solid black; padding: 5px; background-color: #90EE90;">RoHS-2 2011/65/EU</div> <div style="border: 1px solid black; border-radius: 50%; padding: 5px;">XX=Plating Code See Below</div> <div style="border: 1px solid black; border-radius: 50%; padding: 5px;">For Electrical, Mechanical & Environmental Data, See page 264</div> </div>		
SPECIFY PLATING CODE XX=		
Pin Plating	10 μ Au	

SPRING-LOADED CONNECTORS

SERIES 856, 857 • .050" GRID CONCAVE FACE TARGET CONNECTORS FOR SPRING-LOADED ASSEMBLIES • SINGLE AND DOUBLE ROW STRIPS

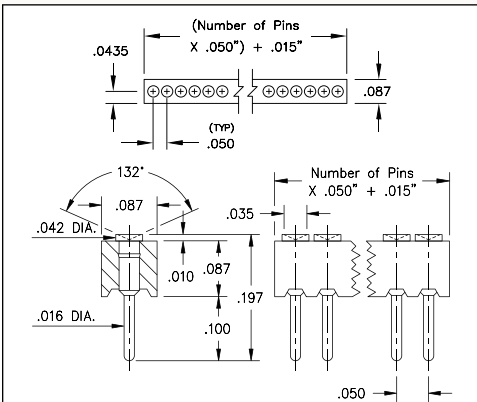
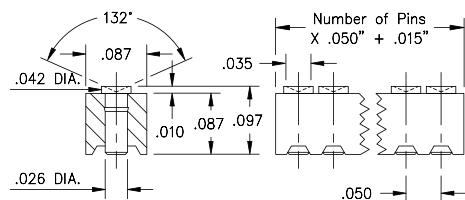

FIG. 1



Coplanarity .005". For Pin counts >20 positions, consult Technical Support.

FIG. 2

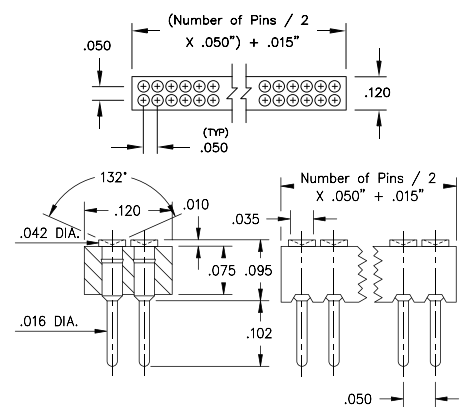
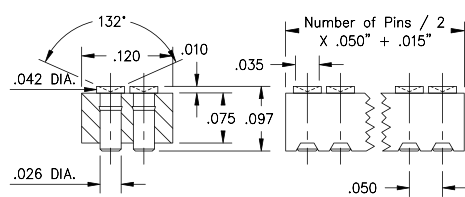

FIG. 3





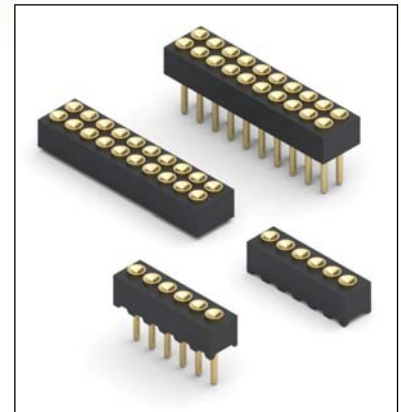

Coplanarity .005". For Pin counts >40 positions, consult Technical Support.

FIG. 4

- Series 856 and 857 Target Connectors, SMT & through-hole, supplied in single and double row strips
- Target Connectors provide an excellent gold-plated conductive mating surface for spring loaded connectors. These series are offered with a concave face for making contact with our standard .019" dia. spring pin plungers
- Target connectors use MM #1934 (through-hole) and #1936 (surface mount) pins. See page 223.2 for details
- Insulators are high temperature thermoplastic



ORDERING INFORMATION

FIG. 1	Series 856...10-002 Concave face / Solder Tails
	856-10-0__-10-002000 Specify number of pins 01-20
FIG. 2	Series 856...30-002 Concave face / Surface Mount
	856-10-0__-30-002000 Specify number of pins 02-20
FIG. 3	Series 857...10-002 Concave face / Solder Tails
	857-10-0__-10-002000 Specify number of pins 04-40
FIG. 4	Series 857...30-002 Concave face / Surface Mount
	857-10-0__-30-002000 Specify number of pins 04-40
  	
SPECIFY PLATING CODE XX=	10 
Pin Plating 	10 μ" Au

