

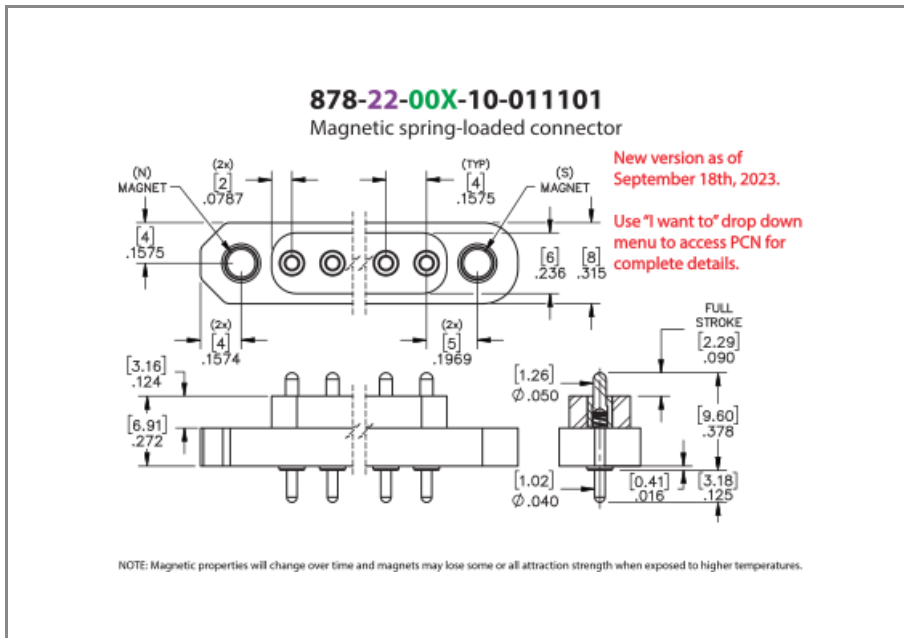

PRODUCT NUMBER: 878-22-002-10-011101

www.mill-max.com
DATA SHEET



General Information	
1 Product Lifecycle:	Active
Product Family:	Spring-Loaded Connector
2 Type:	Maxnetic® Pogo Pin Header Strip
3 Description:	PCB Mount Spring-Loaded Header
Description2:	Magnetic Vertical Mount Through-Hole
Pitch:	.158" (4,001mm)
Number of Pins:	2
Head Type:	Plunger
Tail Type:	Solder Tail
Operating Temperature Range:	-55/+80° C
Country of Origin:	USA
4 ROHS:	Yes

878-22-002-10-011101 - SPECIFICATIONS

Product Attributes	
Plating Code:	22 - Body/Plunger Plating: 20μ" Gold - Spring Plating: 10μ" Gold
Insulator Material:	Nylon 4/6
Rows:	Single Row
Frame Type:	N/A
5 Spring Number:	62 - Low Force Stainless Steel (Click For Graphs)
Plunger Type:	Round
Stroke:	.090" (2,286mm)
Mid Stroke:	.045
Mounting Tab:	Mounting Tabs with Magnetic Inserts

Key Dimensions	
Head Diameter:	.050" (1,270mm)
Initial Height:	.378" (9,601mm)
Insulator Height:	.272" (6,909mm)

Electrical Specifications	
Contact Resistance:	25.00mΩ Max
Insulation Resistance:	10,000 MΩ min.
Rated Voltage:	100 VRMS/150 VDC
Dielectric Withstanding Voltage:	1,000 VRMS min.

Mechanical Specifications	
Mechanical life (Durability):	100,000 to 1,000,000 Cycles @ Mid-Stroke
6 Shock:	No Elect. Discontinuity > 1μs @ 50g
7 Vibration:	No Elect. Discontinuity > 1μs @ 10-2000HZ, 15 G

Mounting Specifications	
Mounting Type:	Mounting Tabs with Magnetic Inserts
Mounting Tab:	Mounting Tabs with Magnetic Inserts

Environmental & Export Classifications

Cage Code:	3N087
ECCN:	Contact Factory
HTSUS:	8536.90.4040
Moisture Sensitivity Level (MSL):	1 (Unlimited)
Prop 65:	N
REACH Status:	REACH Unaffected
Special Handling Code:	UNDF
Static Sensitive:	N

Packaging Information

8 Packaging:	Packaged in Box or Tube
Tape Width:	N/A
Quantity Per Tube:	23

NOTES:

1. Part is Active and in Production, No Scheduled Obsolescence
2. Magnetic force can change over time due to heat exposure.
3. **Standard Tolerances**

Assembly tolerance: +/- .010" (.25mm)

Connector Length "L"

Connector Length "L"	Tolerance
$L \leq 2"$ ($L \leq 50.8$ mm)	+/- .005" (+/- .127 mm)
$2 < L \leq 3"$ ($50.8 < L \leq 76.2$ mm)	+ .007 / - .006" (+ .178 / -.152 mm)
$3 < L \leq 4"$ ($76.2 < L \leq 101.6$ mm)	+ .009 / - .007" (+ .229 / -.178 mm)
$4 < L \leq 5"$ ($101.6 < L \leq 127$ mm)	+ .011 / - .008" (+ .279 / -.203 mm)
$5 < L \leq 6.4"$ ($127 < L \leq 162.56$ mm)	+ .013 / - .009" (+ .330 / -.229 mm)

Insulator width: +/- .005 (.13mm)

Insulator height: +/- .005 (.13mm)

Co-planarity of SMT connectors: .005" (.13mm) up to 1" (25.4mm) in connector length

Insulator Flatness: .005" (.13mm) up to 1" (25.4mm) in connector length

Pin Length: +/- .006 (.15mm)

Pin Diameter: +/- .002 (.051mm)

Pin Angle: +/- 2°

4. Mill-Max products labeled with the RoHS symbol are compliant with all three ROHS Directives. All of our products previously described as RoHS (2002/95/EC) and RoHS-2 (2011/65/EC) are also compliant with RoHS-3 (2015/863/EU).
5. Current ratings are based on the pin tested in free air; the performance may be moderated when used in a connector.
6. For discrete pin only. Per IEC 60512-6-3: Test 6c: Shock
7. For discrete pin only. Per IEC 60512-6-4: Test 6d: Vibration (sinusoidal)
8. Not all part numbers in the series may be packaged in tubes. Some specific part numbers may be packaged in a box.

ADDITIONAL PARTS, PACKAGING & ASSEMBLY INFO

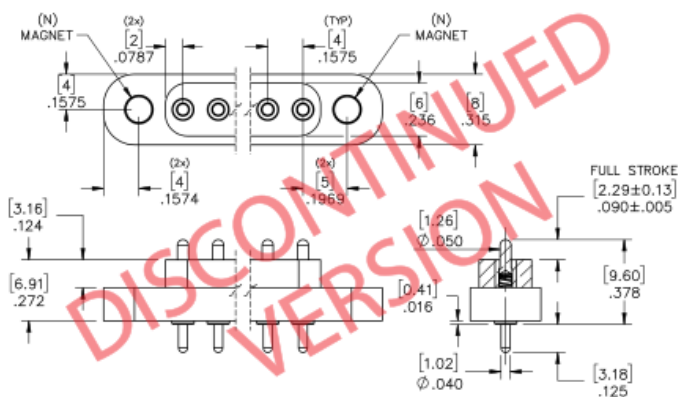

ADDITIONAL NOTES AND SPECIFICATIONS

In the interest of improved design, quality and performance , Mill-Max reserves the right to make changes in its specifications without prior notice. Specifications and tolerances are provided wherever possible. The tolerance on dimensions of critical to function features is typically held tighter than the stated standard tolerances, such as press-fits, holes and lengths affecting the coplanarity of SMT products. Due to the wide variety of interconnects Mill-Max offers, the specific tolerances vary from product to product. If you need information regarding the tolerance of a particular part, please contact Technical Services.

RELATED LINKS AND DOCUMENTS

- Product Detail: [878-22-002-10-011101 - PCB Mount Spring-Loaded Header](#)
- Engineering Notebook: [Introduction to Spring-Loaded Pogo Pins & Connectors](#)
- Environmental Compliance: <https://www.mill-max.com/rohs>