

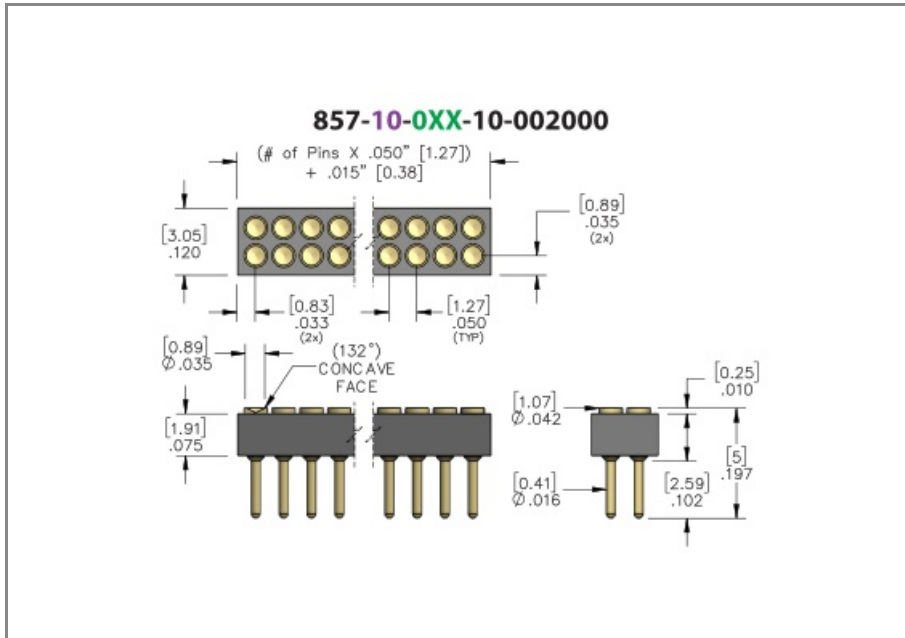

PRODUCT NUMBER: 857-10-018-10-002000

www.mill-max.com
DATA SHEET



General Information	
1 Product Lifecycle:	Active
Product Family:	Spring-Loaded Connector
Type:	Pad Connector with Concave Face
2 Description:	PCB Mount Target Pad Header
Description2:	Vertical Mount Through Hole with Concave Face
Pitch:	.050" (1,270mm)
Number of Pins:	18
3 Operating Temperature Range:	-55/+125° C
Country of Origin:	USA
4 ROHS:	Yes

857-10-018-10-002000 - SPECIFICATIONS

Product Attributes	
5 Plating Code:	10 - shell: 10 μ " Gold over 100 μ " Nickel
Insulator Material:	Nylon 4/6
Rows:	Double Row
Frame Type:	N/A
Contact Number:	N/A
Target Face Type:	Concave Face

Key Dimensions	
Insulator Height:	.075" (1,905mm)

Electrical Specifications	
Insulation Resistance:	10,000 M Ω min.
Rated Voltage:	100 VRMS/150 VDC
Dielectric Withstanding Voltage:	1,000 VRMS min.

Mechanical Specifications	
6 Shock:	No Elect. Discontinuity > 1 μ s @ 50g
7 Vibration:	No Elect. Discontinuity > 1 μ s @ 10-2000HZ, 15 G

Mounting Specifications	
Mounting Type:	Through Hole Solder Mount

Packaging Information	
8 Packaging:	Packaged in Box or Tube
Tape Width:	N/A

Environmental & Export Classifications

REACH Status:	REACH Unaffected
ECCN:	Contact Factory
HTSUS:	8536.90.4040
Cage Code:	3N087
Moisture Sensitivity Level (MSL):	1 (Unlimited)
Special Handling Code:	UNDF
Prop 65:	N
Static Sensitive:	N

NOTES:

1. Part is Active and in Production, No Scheduled Obsolescence

2. **Standard Tolerances**

Assembly tolerance: +/- .010" (.25mm)

Connector Length "L"

Connector Length "L"	Tolerance
$L \leq 2"$ ($L \leq 50.8$ mm)	+/- .005" (+/- .127 mm)
$2 < L \leq 3"$ ($50.8 < L \leq 76.2$ mm)	+ .007 / - .006" (+ .178 / -.152 mm)
$3 < L \leq 4"$ ($76.2 < L \leq 101.6$ mm)	+ .009 / - .007" (+ .229 / -.178 mm)
$4 < L \leq 5"$ ($101.6 < L \leq 127$ mm)	+ .011 / - .008" (+ .279 / -.203 mm)
$5 < L \leq 6.4"$ ($127 < L \leq 162.56$ mm)	+ .013 / - .009" (+ .330 / -.229 mm)

Insulator width: +/- .005 (.13mm)

Insulator height: +/- .005 (.13mm)

Co-planarity of SMT connectors: .005" (.13mm) up to 1" (25.4mm) in connector length

Insulator Flatness: .005" (.13mm) up to 1" (25.4mm) in connector length

Pin Length: +/- .005 (.13mm)

Pin Diameter: +/- .002 (.051mm)

Pin Angle: +/- 2°

3. Per IEC 60512-11-(4,-9,-10,-12)

4. Mill-Max products labeled with the RoHS symbol are compliant with all three ROHS Directives. All of our products previously described as RoHS (2002/95/EC) and RoHS-2 (2011/65/EC) are also compliant with RoHS-3 (2015/863/EU).

5. **Pin Plating:** 10 μ " Gold over 100 μ " Nickel

6. For discrete pin only. Per IEC 60512-6-3: Test 6c: Shock

7. For discrete pin only. Per IEC 60512-6-4: Test 6d: Vibration (sinusoidal)

8. Not all part numbers in the series may be packaged in tubes. Some specific part numbers may be packaged in a box.

ADDITIONAL PARTS, PACKAGING & ASSEMBLY INFO

Suggested P.C.B. Footprint

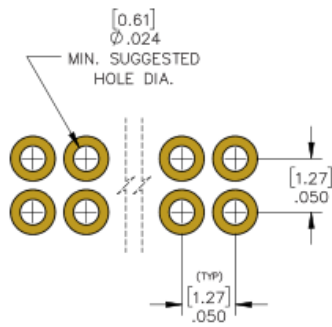

ADDITIONAL NOTES AND SPECIFICATIONS

In the interest of improved design, quality and performance, Mill-Max reserves the right to make changes in its specifications without prior notice. Specifications and tolerances are provided wherever possible. The tolerance on dimensions of critical to function features is typically held tighter than the stated standard tolerances, such as press-fits, holes and lengths affecting the coplanarity of SMT products. Due to the wide variety of interconnects Mill-Max offers, the specific tolerances vary from product to product. If you need information regarding the tolerance of a particular part, please contact Technical Services.

RELATED LINKS AND DOCUMENTS

- Product Detail: [857-10-018-10-002000 - Spring-Loaded Header](#)
- Engineering Notebook: [Introduction to Spring-Loaded Pogo Pins & Connectors](#)
- Environmental Compliance: <https://www.mill-max.com/rohs>