

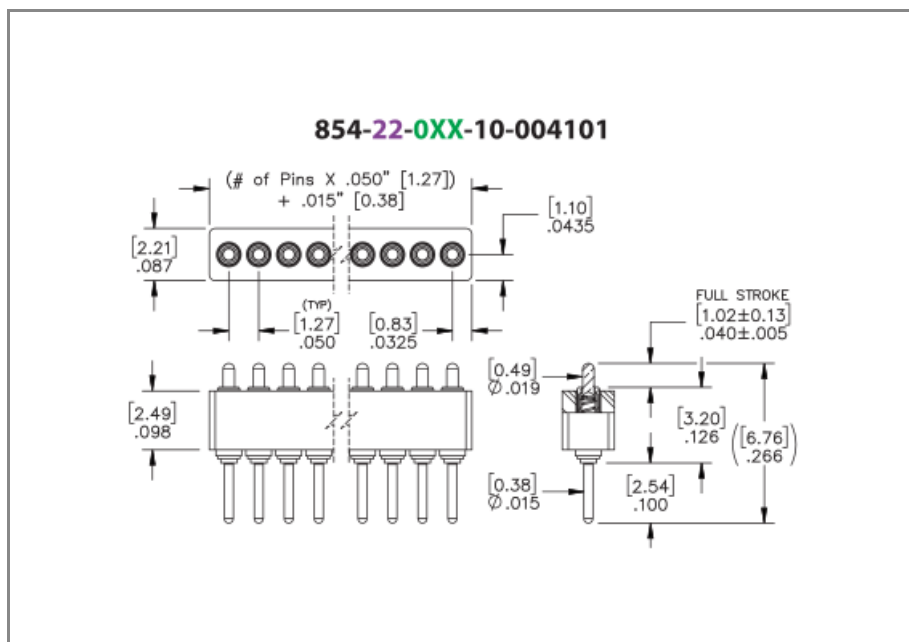

PRODUCT NUMBER: 854-22-002-10-004101

www.mill-max.com  
DATA SHEET



General Information	
1 Product Lifecycle:	Active
Product Family:	Spring-Loaded Connector
Type:	Pogo Pin Header Strip
2 Description:	PCB Mount Spring-Loaded Header
Description2:	Vertical Mount Through-Hole
Pitch:	.050" (1,270mm)
Number of Pins:	2
Head Type:	Plunger
3 Operating Temperature Range:	-55/+125° C
Country of Origin:	USA
4 ROHS:	Yes

## 854-22-002-10-004101 - SPECIFICATIONS

Product Attributes	
Plating Code:	22 - Body/Plunger Plating: 20μ" Gold - Spring Plating: 10μ" Gold
Insulator Material:	Nylon 4/6
Rows:	Single Row
Frame Type:	N/A
5 Spring Number:	64 - Standard Force Spring Stainless Steel (Click For Graphs)
Plunger Type:	Round
Stroke:	.040" (1,016mm)
Mid Stroke:	0.02

Key Dimensions	
Head Diameter:	.019" (0,483mm)
Initial Height:	.266" (6,756mm)
Insulator Height:	.098" (2,489mm)

Electrical Specifications	
Contact Resistance:	20.00mΩ Max
Rated Voltage:	100 VRMS/150 VDC

Mounting Specifications	
Mounting Type:	Through Hole Solder Mount
SMT Pad Size:	N/A

Environmental & Export Classifications	
Cage Code:	3N087
ECCN:	Contact Factory
HTSUS:	8536.90.4040
Moisture Sensitivity Level (MSL):	1 (Unlimited)
Prop 65:	N
REACH Status:	REACH Unaffected
Special Handling Code:	UNDF
Static Sensitive:	N

## Packaging Information

6 Packaging:	Packaged in Box or Tube
Tape Width:	N/A

## NOTES:

1. Part is Active and in Production, No Scheduled Obsolescence

2. **Standard Tolerances**

Assembly tolerance: +/- .010" (.25mm)

Connector Length "L"

Connector Length "L"	Tolerance
$L \leq 2"$ ( $L \leq 50.8$ mm)	+/- .005" (+/- .127 mm)
$2 < L \leq 3"$ ( $50.8 < L \leq 76.2$ mm)	+ .007 / - .006" (+ .178 / - .152 mm)
$3 < L \leq 4"$ ( $76.2 < L \leq 101.6$ mm)	+ .009 / - .007" (+ .229 / - .178 mm)
$4 < L \leq 5"$ ( $101.6 < L \leq 127$ mm)	+ .011 / - .008" (+ .279 / - .203 mm)
$5 < L \leq 6.4"$ ( $127 < L \leq 162.56$ mm)	+ .013 / - .009" (+ .330 / - .229 mm)

Insulator width: +/- .005 (.13mm)

Insulator height: +/- .005 (.13mm)

Co-planarity of SMT connectors: .005" (.13mm) up to 1" (25.4mm) in connector length

Insulator Flatness: .005" (.13mm) up to 1" (25.4mm) in connector length

Pin Length: +/- .006 (.15mm)

Pin Diameter: +/- .002 (.051mm)

Pin Angle: +/- 2°

3. Per IEC 60512-11-(4,-9,-10,-12)

4. Mill-Max products labeled with the RoHS symbol are compliant with all three ROHS Directives. All of our products previously described as RoHS (2002/95/EC) and RoHS-2 (2011/65/EC) are also compliant with RoHS-3 (2015/863/EU).

5. Current ratings are based on the pin tested in free air; the performance may be moderated when used in a connector.

6. Not all part numbers in the series may be packaged in tubes. Some specific part numbers may be packaged in a box.

## ADDITIONAL PARTS, PACKAGING & ASSEMBLY INFO

### Suggested P.C.B. Footprint

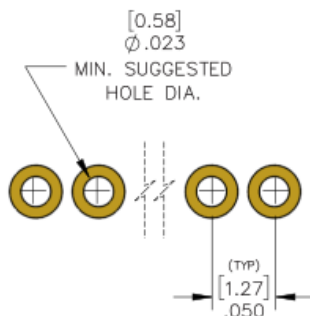

## ADDITIONAL NOTES AND SPECIFICATIONS

In the interest of improved design, quality and performance , Mill-Max reserves the right to make changes in its specifications without prior notice. Specifications and tolerances are provided wherever possible. The tolerance on dimensions of critical to function features is typically held tighter than the stated standard tolerances, such as press-fits, holes and lengths affecting the coplanarity of SMT products. Due to the wide variety of interconnects Mill-Max offers, the specific tolerances vary from product to product. If you need information regarding the tolerance of a particular part, please contact Technical Services.

## RELATED LINKS AND DOCUMENTS

- Product Detail: [854-22-002-10-004101 - PCB Mount Spring-Loaded Header](#)
- Engineering Notebook: [Introduction to Spring-Loaded Pogo Pins & Connectors](#)
- Environmental Compliance: <https://www.mill-max.com/rohs>