

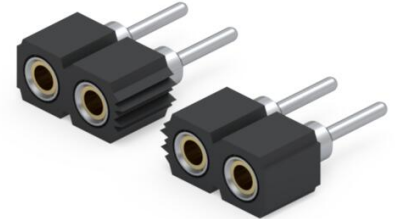

PRODUCT NUMBER: 801-43-054-10-003000

www.mill-max.com  
DATA SHEET

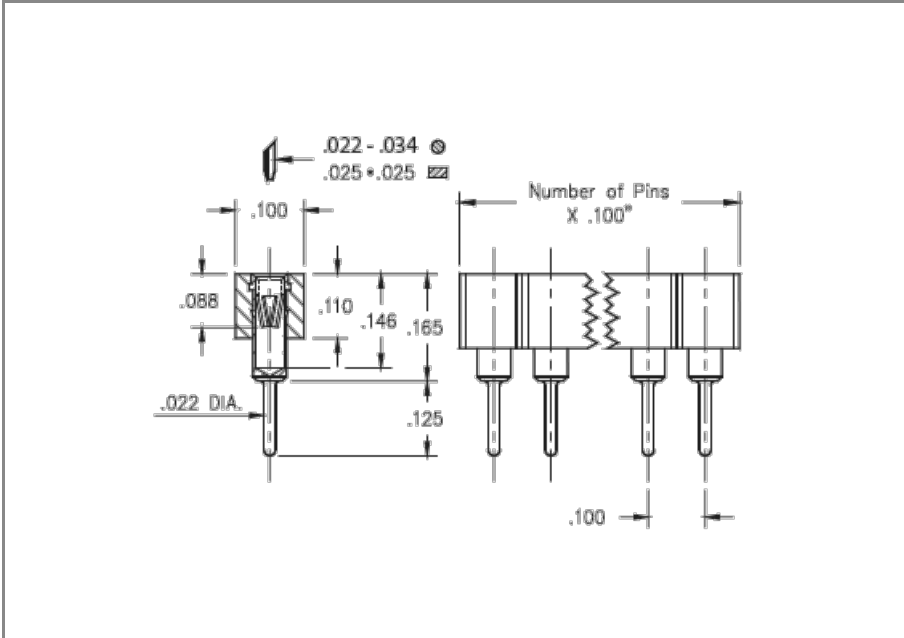

General Information	
1 Product Lifecycle:	Active
Product Family:	PCB Connector
Type:	Machined Pin Socket
2 Description:	Standard Solder Tail Socket
Description2:	Accepts .022" - .034" (0,559 - 0,864 mm)dia leads
Pitch:	.100" (2,540mm)
Number of Pins:	54
Tail Type:	Solder Tail
3 Operating Temperature Range:	-55/+125° C
Country of Origin:	USA
4 ROHS:	Yes

## 801-43-054-10-003000 - SPECIFICATIONS

Product Attributes	
5 Plating Code:	43 - shell: 200 $\mu$ " Tin (matte finish) over 100 $\mu$ " Nickel - inner contact: 30 $\mu$ " Gold over 50 $\mu$ " Nickel
Insulator Material:	High Temp Thermoplastic
Rows:	Single Row
Frame Type:	N/A
Contact Number:	16 - Low Force 6 Finger Contact
Mounting Tab:	N/A

Key Dimensions	
Accepting Lead Range:	.022"-.034" (0,559-0,864mm)
Above Board Height:	.165" (4,191mm)
Insulator Height:	.110" (2,794mm)
Mating Pin Diameter:	.022"-.034" (0,559-0,864mm)
Tail Diameter:	.022" (0,559mm)
Tail Length:	.125" (3,175mm)

Electrical Specifications	
6 Current Rating:	3 Amps
Contact Resistance:	10.00m $\Omega$ Max
Insulation Resistance:	10,000 M $\Omega$ min.
Rated Voltage:	100 VRMS/150 VDC
Dielectric Withstanding Voltage:	1,000 VRMS min.

Mounting Specifications	
Mounting Type:	Through Hole Solder Mount
Mounting Hole:	.030" (0,762mm)
Mounting Tab:	N/A
SMT Pad Size:	N/A

Packaging Information	
7 Packaging:	Packaged in Box or Tube
Tape Width:	N/A

## Environmental & Export Classifications

REACH Status:	REACH Unaffected
ECCN:	Contact Factory
HTSUS:	8536.90.4040
Cage Code:	3N087
Moisture Sensitivity Level (MSL):	1 (Unlimited)
Special Handling Code:	UNDF
Prop 65:	N
Static Sensitive:	N

## NOTES:

1. Part is Active and in Production, No Scheduled Obsolescence

2. **Standard Tolerances**

Assembly tolerance: +/- .010" (.25mm)

Connector Length "L"

Connector Length "L"	Tolerance
$L \leq 2"$ ( $L \leq 50.8$ mm)	+/- .005" (+/- .127 mm)
$2 < L \leq 3"$ ( $50.8 < L \leq 76.2$ mm)	+ .007 / - .006" (+ .178 / -.152 mm)
$3 < L \leq 4"$ ( $76.2 < L \leq 101.6$ mm)	+ .009 / - .007" (+ .229 / -.178 mm)
$4 < L \leq 5"$ ( $101.6 < L \leq 127$ mm)	+ .011 / - .008" (+ .279 / -.203 mm)
$5 < L \leq 6.4"$ ( $127 < L \leq 162.56$ mm)	+ .013 / - .009" (+ .330 / -.229 mm)

Insulator width: +/- .005 (.13mm)

Insulator height: +/- .005 (.13mm)

Co-planarity of SMT connectors: .005" (.13mm) up to 1" (25.4mm) in connector length

Insulator Flatness: .005" (.13mm) up to 1" (25.4mm) in connector length

Pin Length: +/- .005 (.13mm)

Pin Diameter: +/- .002 (.051mm)

Pin Angle: +/- 2°

3. Per IEC 60512-11-(4,-9,-10,-12)

4. Mill-Max products labeled with the RoHS symbol are compliant with all three ROHS Directives. All of our products previously described as RoHS (2002/95/EC) and RoHS-2 (2011/65/EC) are also compliant with RoHS-3 (2015/863/EU).

5. **Shell Plating:** 200  $\mu$ " Tin (matte finish) over 100  $\mu$ " Nickel

**Contact/Clip Plating:** 30  $\mu$ " Gold over 50  $\mu$ " Nickel

6. Per IEC 60512-5-1, Current Carrying Capacity (evaluated at 10° C Temp. Rise)

7. Not all part numbers in the series may be packaged in tubes. Some specific part numbers may be packaged in a box.

## ADDITIONAL NOTES AND SPECIFICATIONS

In the interest of improved design, quality and performance , Mill-Max reserves the right to make changes in its specifications without prior notice. Specifications and tolerances are provided wherever possible. The tolerance on dimensions of critical to function features is typically held tighter than the stated standard tolerances, such as press-fits, holes and lengths affecting the coplanarity of SMT products. Due to the wide variety of interconnects Mill-Max offers, the specific tolerances vary from product to product. If you need information regarding the tolerance of a particular part, please contact Technical Services.

## RELATED LINKS AND DOCUMENTS

- Product Detail: [801-43-054-10-003000 - Standard Solder Tail Socket](#)
- Engineering Notebook: [Introduction to Machined Pin PCB Connectors & Interconnects](#)
- Environmental Compliance: <https://www.mill-max.com/rohs>