



PRODUCT NUMBER: 0900-3-57-20-75-14-11-0

www.mill-max.com
DATA SHEET

0900-X-XX-20-7X-14-11-0
Surface mount on .082 Dia. min. solder pad

Basic Part Number	Length (A)	MID. Stroke (B)	Length (C)
* 0900-0	.137	.0195	.098
* 0900-1	.177	.0275	.106
* 0900-2	.197	.0275	.106
* 0900-3	.217	.0275	.106
0900-4	.236	.0275	.106
0900-8	.155	.0195	.106

* Available packaged on Tape & Reel

Standard Tolerances:
Lengths: ±.006
Diameters: ±.002
Angles: ±2°



General Information	
1 Product Lifecycle:	Active
Product Family:	Discrete Spring Loaded Pins
2 Description:	Surface Mount Spring-Loaded Pin
3 Shell/Plunger Material:	Brass Alloy
Spring Number:	75 - Standard Force Beryllium Copper (Click For Graphs)
Spring Material:	Beryllium Copper
4 Operating Temperature Range:	-55/+125° C
Country of Origin:	USA
5 ROHS:	Yes

Termination Style	
Target Face Type:	N/A
Tail Type:	No Tail
Tail:	None
Wire Termination:	N/A

0900-3-57-20-75-14-11-0 - SPECIFICATIONS

Product Attributes	
6 Shell/Plunger Plating:	20: Body/Plunger Plating - 20 μ" Gold over Nickel
7 Spring Plating:	14 Spring Plating - 10 μ" Gold over Nickel
Plunger Type:	Round
Plunger Diameter:	.042" (1,067mm)
Max Stroke:	.055" (1,397mm)
Rated Travel (Mid-Stroke):	.028" (0,711mm)
Spring Force (Initial):	10g
Spring Force (Mid-Stroke):	60g

Key Dimensions	
Barb/Knurl Diameter:	.064" (1,626mm)
Body Diameter:	.059" (1,499mm)
Body Length:	.090" (2,286mm)
Flange Diameter:	.072" (1,829mm)
Flange Length:	.016" (0,406mm)
Head Diameter:	N/A
Hole Depth:	N/A
Initial Height:	.217" (5,512mm)
Overall Length:	.217" (5,512mm)
Tail Diameter:	No Tail
Tail Length:	N/A

Electrical Specifications	
Maximum Current:	6.5A @ 30° C Temp. Rise
8 Maximum Derated Current:	5.20A
Contact Resistance:	20.00mΩ Max

Mechanical Specifications	
Mechanical life (Durability):	100,000 to 1,000,000 Cycles @ Mid-Stroke
9 Shock:	No Elect. Discontinuity > 1μs @ 50g
10 Vibration:	No Elect. Discontinuity > 1μs @ 10-2000HZ, 20 G

Mounting Specifications

Mounting Feature:	Surface Mount
Mounting Hole Type:	Surface Mount
Mounting Hole:	N/A
Alternate Mounting:	N/A
Alternate Mounting Hole:	N/A
SMT Pad Size:	Circular - .082"

Packaging Information

Packaging:	57 - Vertically on Tape & Reel
Reel Size:	13"
Quantity Per Reel:	1,100

Environmental & Export Classifications

REACH Status:	REACH Unaffected
ECCN:	Contact Factory
HTSUS:	8536.90.4000
Cage Code:	3N087
Moisture Sensitivity Level (MSL):	1 (Unlimited)
Special Handling Code:	UNDF
Prop 65:	N
Static Sensitive:	N

NOTES:

1. Part is Active and in Production, No Scheduled Obsolescence
2. Standard Tolerances:
Lengths +/- .006" (0,15)
Diameters: +/- .002" (0,051)
Angles: +/- 2°
3. Brass Alloy 360 per ASTM B 16, or 385 per ASTM B455
4. Storage per IEC 60512-11-(4,9,10,12) and peak operating temperature per IEC 60512-5-2, Test 5b
5. Mill-Max products labeled with the RoHS symbol are compliant with all three ROHS Directives. All of our products previously described as RoHS (2002/95/EC) and RoHS-2 (2011/65/EC) are also compliant with RoHS-3 (2015/863/EU).
6. GOLD per ASTM B 488, Type 1 (99.7% min. gold), Code C (130-200 HK {Knoop hardness}); NICKEL per ASTM B 689, Type 2 (Bright)
7. GOLD per ASTM B 488, Type 1 (99.7% min. gold), Code C (130-200 HK {Knoop hardness}), NICKEL per ASTM B 689, Type 2 (Bright)
8. Per IEC 60512-5-2; Current Carrying Capacity; Current Derating
9. Per IEC 60512-6-3: Test 6c: Shock
10. Per IEC 60512-6-4: Test 6d: Vibration (sinusoidal)

ADDITIONAL PARTS, PACKAGING & ASSEMBLY INFO

0900-0-15-20-76-14-11-0

Surface mount on .082 Dia. min. solder pad. Also available on 16mm wide X 8mm pitch carrier tape: 2,000 parts per 13" reel
Order as: 0900-0-57-20-76-14-11-0

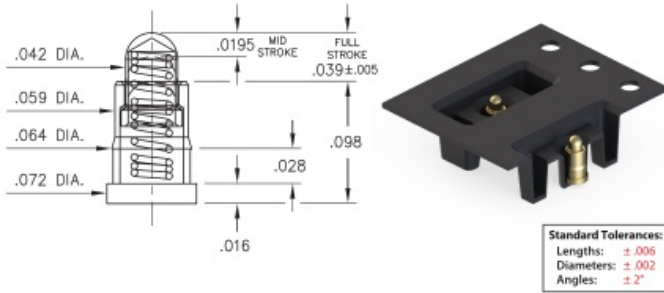

0900-0-59-20-76-14-11-0

Special Tape & Reel packaging option: **Plunger side down**
Available on 16mm wide X 8mm pitch carrier tape: 2,075 parts per 13" reel
Pick and place solution for through-hole applications

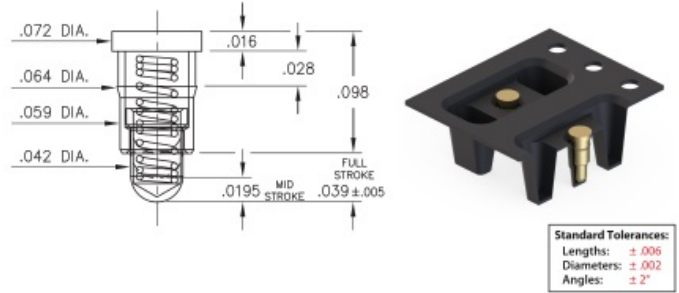

0900-1-15-20-7X-14-11-0

Surface mount on .082 Dia. min. solder pad. Also available on 16mm wide X 8mm pitch carrier tape: 1,500 parts per 13" reel
Order as: 0900-1-57-20-7X-14-11-0

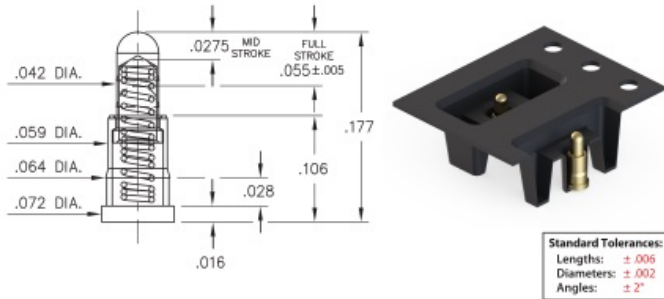

0900-1-59-20-7X-14-11-0

Special Tape & Reel packaging option: **Plunger side down**
Available on 16mm wide X 8mm pitch carrier tape: 1,700 parts per 13" reel
Pick and place solution for through-hole applications

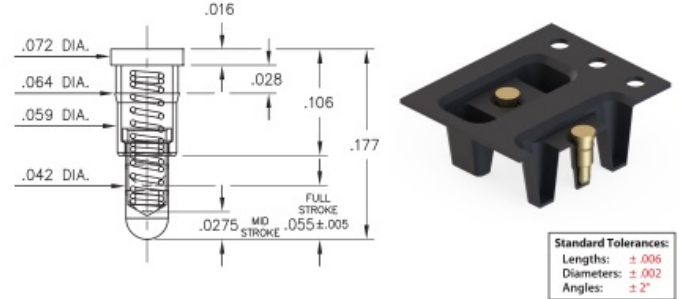

0900-2-15-20-7X-14-11-0

Surface mount on .082 Dia. min. solder pad. Also available on 24mm wide X 8mm pitch carrier tape: 1,100 parts per 13" reel
Order as: 0900-2-57-20-7X-14-11-0

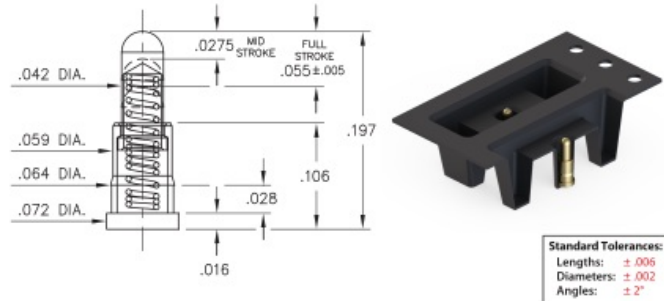

0900-3-15-20-7X-14-11-0

Surface mount on .082 Dia. min. solder pad. Also available on 24mm wide X 8mm pitch carrier tape: 1,100 parts per 13" reel
Order as: 0900-3-57-20-7X-14-11-0

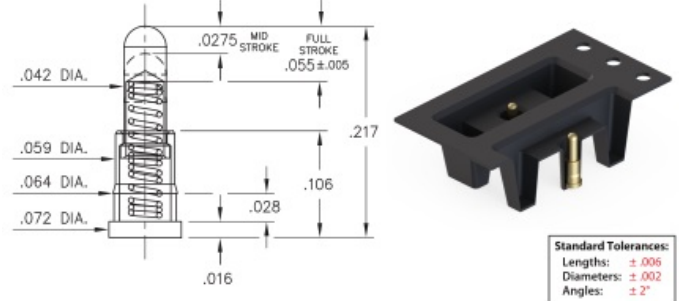

0900-4-15-20-7X-14-11-0

Standard stroke
Surface mount on .082 Dia. min. solder pad

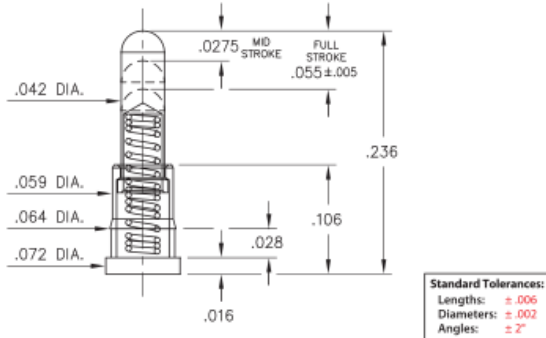

0900-8-15-20-76-14-11-0

Short stroke
Surface mount on .082 Dia. min. solder pad

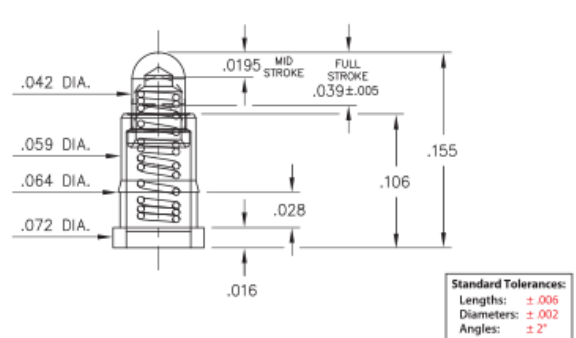

SPRING:

#75 SPRING STANDARD FORCE SPRING	Full Stroke Capability : .055"± .005" [1,4 ± 0,127]
Spring Material : Beryllium Copper Alloy 172	Force @ Mid. Stroke : 60 g ± 20 g
Mid. Stroke : .0275" [0,7]	Initial Force (Pre-Load) : 10 g

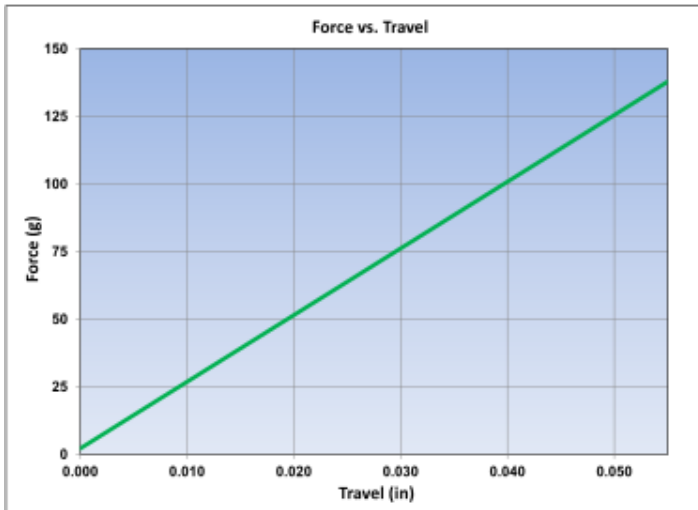

The stroke, force and current rating values are measured using spring pins with an internal construction per the design specification. Individual spring pin performance may vary from these values based on design differences.

Material	Beryllium Copper	Grams Force	60g
Max Stroke	.055" (1,397mm)	Maximum Current	6.5A @ 30° C Temp. Rise
Maximum Operating Temp @ Max Current	120.00° C	20% De-rated Maximum Current	5.20A
Contact Resistance	20.00mΩ Max		

ADDITIONAL NOTES AND SPECIFICATIONS

In the interest of improved design, quality and performance , Mill-Max reserves the right to make changes in its specifications without prior notice. Specifications and tolerances are provided wherever possible. The tolerance on dimensions of critical to function features is typically held tighter than the stated standard tolerances, such as press-fits, holes and lengths affecting the coplanarity of SMT products. Due to the wide variety of interconnects Mill-Max offers, the specific tolerances vary from product to product. If you need information regarding the tolerance of a particular part, please contact Technical Services.

RELATED LINKS AND DOCUMENTS

- Product Detail: [0900-3-57-20-75-14-11-0 - Surface Mount Spring-Loaded Pin](#)
- Engineering Notebook: [Introduction to Spring-Loaded Pogo Pins & Connectors](#)
- Environmental Compliance: <https://www.mill-max.com/rohs>