



PRODUCT NUMBER: 2561-4-00-80-00-00-07-0

www.mill-max.com
DATA SHEET

2561-X-00-XX-00-00-07-0

Swage mount in .094 hole

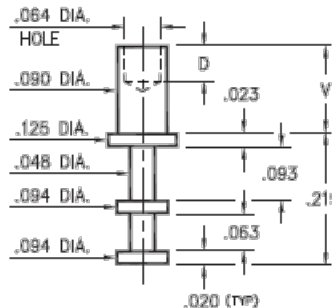

Basic Part Number	Board Thickness	Length V	Depth D
25XX-1	.031	.063	.047
25XX-2	.062	.094	.062
25XX-3	.094	.125	.062
25XX-4	.125	.156	.062

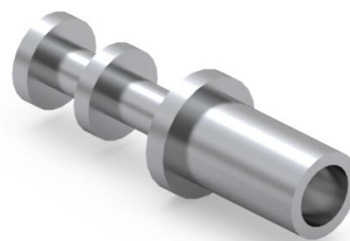

General Information

1 Product Lifecycle:	Active
Product Family:	Printed Circuit Board (PCB) Pin
2 Description:	Turret Terminal Pin
3 Shell Material:	Brass Alloy
4 Shell Plating:	80 : 200 - 300 μ" Tin (matte finish) over Nickel
5 Operating Temperature Range:	- 55/+125° C
Country of Origin:	USA
6 ROHS:	Yes

Termination Style

Tail:	Single
Tail Type:	Turret
Head Type:	Turret
Hole Type:	Closed-Bottom
Wire Termination:	N/A

2561-4-00-80-00-00-07-0 - SPECIFICATIONS

Key Dimensions	
Barb/Knurl Diameter:	N/A
Body Diameter:	.090" (2,286mm)
Body Length:	.156" (3,962mm)
Flange Diameter:	.125" (3,175mm)
Flange Length:	.023" (0,584mm)
Head Diameter:	.094" (2,388mm)
Hole Depth:	.062" (1,575mm)
Overall Length:	.375" (9,525mm)
Tail Diameter:	.090" (2,286mm)
Tail Length:	.156" (3,962mm)

Electrical Specifications	
7 Maximum Current:	Application Specific

Mounting Specifications	
Mounting Feature:	Swage Mount
Mounting Hole Type:	Plated Through Hole (PTH)
Mounting Hole:	.094" (2,388mm)
Alternate Mounting:	N/A
Alternate Mounting Hole:	N/A
SMT Pad Size:	N/A

Packaging Information	
Packaging:	00 - Packaged in Bulk
Reel Size:	N/A

Environmental & Export Classifications	
REACH Status:	REACH Unaffected
ECCN:	Contact Factory
HTSUS:	8536.90.4000
Cage Code:	3N087
Moisture Sensitivity Level (MSL):	1 (Unlimited)
Special Handling Code:	UNDF
Prop 65:	N
Static Sensitive:	N

NOTES:

1. Part is Active and in Production, No Scheduled Obsolescence
2. Standard Tolerances:
Lengths +/- .005" (0,13)
Diameters: +/- .002" (0,051)
Angles: +/- 2°
3. Brass Alloy 360 per ASTM B 16, or 385 per ASTM B455
4. TIN (100%) per ASTM B 545, Matte finish (With whisker and oxide inhibitors); NICKEL per ASTM B 689, Type 2 (Bright)
5. Per IEC 60512-11-(4,-9,-10,-12)
6. Mill-Max products labeled with the RoHS symbol are compliant with all three ROHS Directives. All of our products previously described as RoHS (2002/95/EC) and RoHS-2 (2011/65/EC) are also compliant with RoHS-3 (2015/863/EU).
7. Current Rating is typically a measured function of the female socket/connector. The amount of current a solid, male pin can tolerate is a direct relation of the heat displaced based on current and the ability of neighboring components to handle displaced heat.

ADDITIONAL NOTES AND SPECIFICATIONS

In the interest of improved design, quality and performance, Mill-Max reserves the right to make changes in its specifications without prior notice. Specifications and tolerances are provided wherever possible. The tolerance on dimensions of critical to function features is typically held tighter than the stated standard tolerances, such as press-fits, holes and lengths affecting the coplanarity of SMT products. Due to the wide variety of interconnects Mill-Max offers, the specific tolerances vary from product to product. If you need information regarding the tolerance of a particular part, please contact Technical Services.

RELATED LINKS AND DOCUMENTS

- Product Detail: [2561-4-00-80-00-00-07-0 - Turret Terminal Pin](#)
- Engineering Notebook: [Introduction to Swage Assembly](#)
- Engineering Notebook: [Introduction to Printed Circuit Board PCB Pins](#)
- Environmental Compliance: <https://www.mill-max.com/rohs>